

brother®

USER'S GUIDE

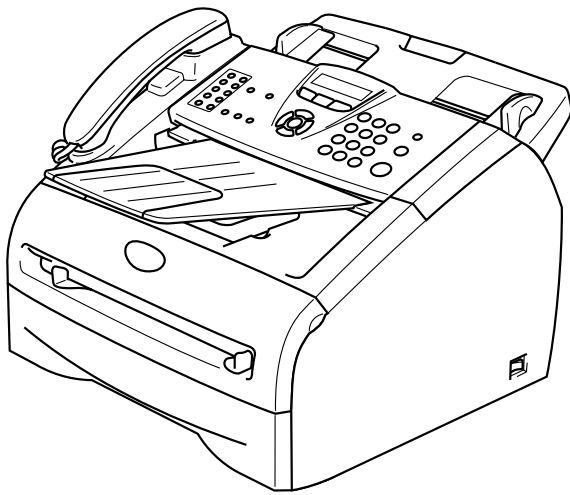

FAX-2820
FAX-2920
MFC-7220
MFC-7225N

Version A

If you need to call Customer Service

Please complete the following information for future reference:

Model Number: FAX-2820, FAX-2920, MFC-7220 and MFC-7225N
(Circle your model number)

Serial Number:* _____

Date of Purchase: _____

Place of Purchase: _____

* The serial number can be displayed on the LCD screen (Menu/Set, 4, 1 (FAX-2820, FAX-2920 and MFC-7220) or Menu/Set, 6, 1 (MFC-7225N)). Retain this User's Guide with your sales receipt as a permanent record of your purchase, in the event of theft, fire or warranty service.

Register your product on-line at

<http://www.brother.com/registration>

By registering your product with Brother, you will be recorded as the original owner of the product. Your registration with Brother:

- may serve as confirmation of the purchase date of your product should you lose your receipt;
- may support an insurance claim by you in the event of product loss covered by insurance; and,
- will help us notify you of enhancements to your product and special offers.

The most convenient and efficient way to register your new product is on-line at <http://www.brother.com/registration>

Brother numbers

IMPORTANT

For technical help, you must call the country where you bought the machine. Calls must be made **from within** that country.

Register your product

By registering your product with Brother International Corporation, you will be recorded as the original owner of the product. Your registration with Brother:

- may serve as confirmation of the purchase date of your product should you lose your receipt;
- may support an insurance claim by you in the event of product loss covered by insurance; and,
- will help us notify you of enhancements to your product and special offers.

Please complete and fax the Brother Warranty Registration And Test Sheet or, for your convenience and most efficient way to register your new product, register on-line at

<http://www.brother.com/registration>

Frequently asked questions (FAQs)

The Brother Solutions Center is our one-stop resource for all your Fax Machine/Multi-Function Center needs. You can download the latest software, documents and utilities, read FAQs and troubleshooting tips, and learn how to get the most from your Brother product.

<http://solutions.brother.com>



Note

You can check here for Brother driver updates.

For Customer Service

In USA: 1-800-284-4329 (voice)
1-901-379-1215 (fax)
1-800-284-3238 (TTY service for the hearing-impaired)

In Canada: 1-877-BROTHER (voice)
(514) 685-4898 (fax)

Service Center Locator (USA only)

For the location of a Brother authorized service center, call 1-800-284-4357.

Service Center Locations (Canada only)

For the location of a Brother authorized service center, call 1-877-BROTHER.

Brother fax back system (USA only)

Brother has installed an easy-to-use fax back system, so you can get instant answers to common technical questions and product information for all Brother products. This system is available 24 hours a day, 7 days a week. You can use the system to receive faxed instructions and an Index of fax back subjects.

In USA only: 1-800-521-2846

Ordering accessories and supplies

For best quality results use only genuine Brother accessories, which are available at most Brother retailers. If you cannot find the accessory you need and you have a Visa, MasterCard, Discover, or American Express credit card, you can order accessories directly from Brother. (In the USA, you can visit us online for a complete selection of the Brother accessories and supplies that are available for purchase.)

In USA: 1-888-879-3232 (voice)
1-800-947-1445 (fax)

<http://www.brothermall.com>

In Canada: 1-877-BROTHER (voice)

Description	Item
Toner Cartridge	TN-350 (Prints up to 2,500 pages)
Drum Unit	DR-350
Telephone Line Cord	LG3077001
Telephone Handset	
Handset Curled Cord	
IEEE-1284 Bi-directional Cable (MFC-7220 and MFC-7225N only)	F2A046-10
Power Protector for A/C Power Telephone Line Surges and Voltage Spikes (2 outlets)	QPD120
Power Protector for A/C Power Telephone Line Surges and Voltage Spikes (8 outlets)	FX120
External Wireless Print/Scan Server (Option) (MFC-7220 and MFC-7225N only)	NC-2200w
External Print Sever (Option) (MFC-7220 and MFC-7225N only)	NC-2100p
User's Guide	LF6772001 (English for USA and Canada) LF6772002 (French for Canada)
Quick Setup Guide	FAX-2820/FAX-2920 LF6771001 (English for USA and Canada) LF6771002 (French for Canada) MFC-7220/MFC-7225N LF6791001 (English for USA and Canada) LF6791002 (French for Canada)

Notice - Disclaimer of Warranties (USA and Canada)

BROTHER'S LICENSOR(S), AND THEIR DIRECTORS, OFFICERS, EMPLOYEES OR AGENTS (COLLECTIVELY BROTHER'S LICENSOR) MAKE NO WARRANTIES, EXPRESS OR IMPLIED, INCLUDING WITHOUT LIMITATION THE IMPLIED WARRANTIES OF MERCHANTABILITY AND FITNESS FOR A PARTICULAR PURPOSE, REGARDING THE SOFTWARE. BROTHER'S LICENSOR(S) DOES NOT WARRANT, GUARANTEE OR MAKE ANY REPRESENTATIONS REGARDING THE USE OR THE RESULTS OF THE USE OF THE SOFTWARE IN TERMS OF ITS CORRECTNESS, ACCURACY, RELIABILITY, CURRENTNESS OR OTHERWISE. THE ENTIRE RISK AS TO THE RESULTS AND PERFORMANCE OF THE SOFTWARE IS ASSUMED BY YOU. THE EXCLUSION OF IMPLIED WARRANTIES IS NOT PERMITTED BY SOME STATES IN THE USA AND SOME PROVINCES IN CANADA. THE ABOVE EXCLUSION MAY NOT APPLY TO YOU.

IN NO EVENT WILL BROTHER'S LICENSOR(S) BE LIABLE TO YOU FOR ANY CONSEQUENTIAL, INCIDENTAL OR INDIRECT DAMAGES (INCLUDING DAMAGES FOR LOSS OF BUSINESS PROFITS, BUSINESS INTERRUPTION, LOSS OF BUSINESS INFORMATION, AND THE LIKE) ARISING OUT OF THE USE OR INABILITY TO USE THE SOFTWARE EVEN IF BROTHER'S LICENSOR HAS BEEN ADVISED OF THE POSSIBILITY OF SUCH DAMAGES. BECAUSE SOME STATES IN THE USA AND SOME PROVINCES IN CANADA DO NOT ALLOW THE EXCLUSION OR LIMITATION OF LIABILITY FOR CONSEQUENTIAL OR INCIDENTAL DAMAGES, THE ABOVE LIMITATIONS MAY NOT APPLY TO YOU. IN ANY EVENT BROTHER'S LICENSOR'S LIABILITY TO YOU FOR ACTUAL DAMAGES FROM ANY CAUSE WHATSOEVER, AND REGARDLESS OF THE FORM OF THE ACTION (WHETHER IN CONTRACT, TORT (INCLUDING NEGLIGENCE), PRODUCT LIABILITY OR OTHERWISE), WILL BE LIMITED TO \$50.

Compilation and Publication Notice

Under the supervision of Brother Industries Ltd., this manual has been compiled and published, covering the latest product descriptions and specifications.

The contents of this manual and the specifications of this product are subject to change without notice.

Brother reserves the right to make changes without notice in the specifications and materials contained herein and shall not be responsible for any damages (including consequential) caused by reliance on the materials presented, including but not limited to typographical and other errors relating to the publication.

Brother® One Year Limited Warranty and Replacement Service (USA only)

Who is covered:

- This limited warranty ("warranty") is given only to the original end-use/retail purchaser (referred to in this warranty as "Original Purchaser") of the accompanying product, consumables and accessories (collectively referred to in this warranty as "this Product").
- If you purchased a product from someone other than an authorized Brother reseller in the United States or if the product was used (including but not limited to floor models or refurbished product), prior to your purchase you are not the Original Purchaser and the product that you purchased is not covered by this warranty.

What is covered:

- This Product includes a Machine and Consumable and Accessory Items. Consumable and Accessory Items include but are not limited to print heads, toner, drums, ink cartridges, print cartridges, refill ribbons, thermal PLUS paper and thermal paper.
- Except as otherwise provided herein, Brother warrants that the Machine and the accompanying Consumable and Accessory Items will be free from defects in materials and workmanship, when used under normal conditions.
- This warranty applies only to products purchased and used in the United States. For products purchased in, but used outside, the United States, this warranty covers only warranty service within the United States (and does not include shipping outside the United States).
- **What is the length of the Warranty Periods:**
- Machines: one year from the original purchase date.
- Accompanying Consumable and Accessory Items: 90 days from the original purchase date or the rated life of consumable, whichever comes first.

What is NOT covered:

This warranty does not cover:

- (1) Physical damage to this Product;
- (2) Damage caused by improper installation, improper or abnormal use, misuse, neglect or accident (including but not limited to transporting this Product without the proper preparation and/or packaging);
- (3) Damage caused by another device or software used with this Product (including but not limited to damage resulting from use of non Brother®-brand parts and Consumable and Accessory Items);

- (4) Consumable and Accessory Items that expired in accordance with a rated life; and,
- (5) Problems arising from other than defects in materials or workmanship.
- (6) Normal Periodic Maintenance Items, such as Paper Feeding Kit, Fuser and Laser Units.

This limited warranty is VOID if this Product has been altered or modified in any way (including but not limited to attempted warranty repair without authorization from Brother and/or alteration/removal of the serial number).

What to do if you think your Product is eligible for warranty service:

Report your issue to either our Customer Service Hotline at 1-800-284-4329 for Fax, MFC and DCP and 1-800-276-7746 for Printers, or to a Brother Authorized Service Center **within the applicable warranty period.** Supply Brother or the Brother Authorized Service Center with a copy of your dated bill of sale showing that this Product was purchased within the U.S. For the name of local Brother Authorized Service Center(s), call 1-800-521-2846.

What Brother will ask you to do:

After contacting Brother or a Brother Authorized Service Center, you may be required to deliver (by hand if you prefer) or send the Product properly packaged, freight prepaid, to the Authorized Service Center together with a photocopy of your bill of sale. **You are responsible for the cost of shipping, packing product, and insurance (if you desire). You are also responsible for loss or damage to this Product in shipping.**

What Brother will do:

If the problem reported concerning your Machine and/or accompanying Consumable and Accessory Items is covered by this warranty and if you first reported the problem to Brother or an Authorized Service Center within the applicable warranty period, Brother or its Authorized Service Center will repair or replace the Machine and/or accompanying Consumable and Accessory Items at no charge to you for parts or labor. The decision as to whether to repair or replace the Machine and/or accompanying Consumable and Accessory Items is made by Brother in its sole discretion.

Brother® One Year Limited Warranty and Replacement Service (USA only)

Brother reserves the right to supply a refurbished or remanufactured replacement Machine and/or accompanying Consumable and Accessory Items and use refurbished parts provided such replacement products conform to the manufacturer's specifications for new product/parts. The repaired or replacement Machine and/or accompanying Consumable and Accessory Items will be returned to you freight prepaid or made available for you to pick up at a conveniently located Authorized Service Center.

If the Machine and/or accompanying Consumable and Accessory Items are not covered by this warranty (either stage), you will be charged for shipping the Machine and/or accompanying Consumable and Accessory Items back to you and charged for any service and/or replacement parts/products at Brother's then current published rates.

The foregoing are your sole (i.e., only) and exclusive remedies under this warranty.

What happens when Brother elects to replace your Machine:

When a replacement Machine is authorized by Brother, and you have delivered the Machine to an Authorized Service Center, the Authorized Service Center will provide you with a replacement Machine after receiving one from Brother. If you are dealing directly with Brother, Brother will send to you a replacement Machine with the understanding that you will, after receipt of the replacement Machine, supply the required proof of purchase information, together with the Machine that Brother agreed to replace. You are then expected to pack the Machine that Brother agreed to replace in the package from the replacement Machine and return it to Brother using the pre-paid freight bill supplied by Brother in accordance with the instructions provided by Brother. Since you will be in possession of two machines, Brother will require that you provide a valid major credit card number. Brother will issue a hold against the credit card account number that you provide until Brother receives your original Product and determines that your original Product is entitled to warranty coverage. Your credit card will be charged up to the cost of a new Product only if: (i) you do not return your original Product to Brother within five (5) business days; (ii) the problems with your original Product are not covered by the limited warranty; (iii) the proper packaging instructions are not followed and has caused

damage to the product; or (iv) the warranty period on your original Product has expired or has not been sufficiently validated with a copy of the proof of purchase (bill of sale). The replacement Machine you receive (even if refurbished or remanufactured) will be covered by the balance of the limited warranty period remaining on the original Product, plus an additional thirty (30) days. You will keep the replacement Machine that is sent to you and your original Machine shall become the property of Brother. **Retain your original Accessory Items and a copy of the return freight bill, signed by the courier.**

Limitations:

Brother is not responsible for damage to or loss of any equipment, media, programs or data related to the use of this Product. Except for that repair or replacement as described above, Brother shall not be liable for any direct, indirect, incidental or consequential damages or specific relief. Because some states do not allow the exclusion or limitation of consequential or incidental damages, the above limitation may not apply to you.

THIS WARRANTY IS GIVEN IN LIEU OF ALL OTHER WARRANTIES, WRITTEN OR ORAL, WHETHER EXPRESSED BY AFFIRMATION, PROMISE, DESCRIPTION, DRAWING, MODEL OR SAMPLE. ANY AND ALL WARRANTIES OTHER THAN THIS ONE, WHETHER EXPRESS OR IMPLIED, INCLUDING IMPLIED WARRANTIES OF MERCHANTABILITY AND FITNESS FOR A PARTICULAR PURPOSE, ARE HEREBY DISCLAIMED.

- This Limited Warranty is the only warranty that Brother is giving for this Product. It is the final expression and the exclusive and only statement of Brother's obligations to you. It replaces all other agreements and understandings that you may have with Brother or its representatives.
- This warranty gives you certain rights and you may also have other rights that may vary from state to state.
- This Limited Warranty (and Brother's obligation to you) may not be changed in any way unless you and Brother sign the same piece of paper in which we (1) refer to this Product and your bill of sale date, (2) describe the change to this warranty and (3) agree to make that change.

Important: *We recommend that you keep all original packing materials, in the event that you ship this Product.*

**BROTHER MULTIFUNCTION CENTER/FACSIMILE MACHINE
LIMITED WARRANTY
(Canada only)**

Pursuant to this limited warranty of 1 year from the date of purchase for labour and parts, Brother International Corporation (Canada) Ltd. ("Brother"), or its Authorized Service Centers, will repair this MFC/Facsimile machine free of charge if defective in material or workmanship. This Limited Warranty does not include cleaning, consumables (including, without limitation, print cartridges, print head, toner and drum) or damage caused by accident, neglect, misuse or improper installation or operation, any damage caused from service, maintenance, modifications, or tampering by anyone other than a Brother Authorized Service Representative, or from the use of supplies or consumable items that are non-Brother products. Operation of the MFC/Facsimile machine in excess of the specifications or with the Serial Number or Rating Label removed shall be deemed abuse and all repairs thereafter shall be the sole liability of the end-user/purchaser. In order to obtain warranty service, the MFC/Facsimile machine must be delivered or shipped freight prepaid by the end user/purchaser to a "Brother" Authorized Service Center, together with your Proof of Purchase in the form of a Sales Receipt.

For laser products: Failure to remove the Toner Cartridge (and Toner Drum Unit on applicable models) during shipping will cause severe damage to the MFC/Facsimile and will VOID the Warranty. (Refer to your User's Guide for proper packaging.)

For ink-jet products: Do not remove the ink cartridges during shipping. Damage to your print head resulting from packing without the ink cartridges will VOID your warranty. (Refer to your User's Guide for proper packaging.)

BROTHER DISCLAIMS ALL OTHER WARRANTIES EXPRESSED OR IMPLIED INCLUDING, WITHOUT LIMITATION, ANY IMPLIED WARRANTIES OF MERCHANTABILITY OR FITNESS FOR A PARTICULAR PURPOSE, EXCEPT TO THE EXTENT THAT ANY WARRANTIES IMPLIED BY LAW CANNOT BE VALIDLY WAIVED.

No oral or written information, advice or representation provided by Brother, its Authorized Service Centers, Distributors, Dealers, Agents or employees, shall create another warranty or modify this warranty. This warranty states Brother's entire liability and your exclusive remedy against Brother for any failure of the MFC/Facsimile machine to operate properly.

Neither Brother nor anyone else involved in the development, production, or delivery of this MFC/Facsimile machine shall be liable for any indirect, incidental, special, consequential, exemplary, or punitive damages, including lost profits, arising from the use of or inability to use the product, even if advised by the end user/purchaser of the possibility of such damages. Since some Provinces do not allow the above limitation of liability, such limitation may not apply to you.

This Limited Warranty gives you specific legal rights and you may also have other rights which vary from Province to Province.

Warranty Service is available at Brother Authorized Service Centers throughout Canada. For Technical Support or for the name and location of your nearest Authorized Service Center call 1-877-BROTHER.

Internet support: support@brother.ca or browse

Brother's Web Site: www.brother.com

Brother International Corporation (Canada) Ltd.
1 Rue Hôtel de Ville
Dollard-Des-Ormeaux, QC H9B 3H6

At your side.
brother®

Safety precautions

We use the following icons throughout this User's Guide.



Warnings tell you what to do to prevent possible personal injury.



Electrical Hazard icons alert you to a possible electrical shock.



Hot Surface icons warn you not to touch machine parts that are hot.



Cautions specify procedures you must follow or avoid to prevent possible damage to the machine or other objects.



Improper Setup icons alerts you to devices and operations that are not compatible with the machine.



Notes tell you how you should respond to a situation that may arise or give tips about how the operation works with other features.

To use the machine safely

Please keep these instructions for later reference and read them before attempting any maintenance.



Note

(For FAX-2820 and MFC-7220) If there are faxes in the machine's memory, you need to print them or save them before you turn off the power and unplug the machine. (To print the faxes in the memory, see *Printing a fax from the memory* on page 4-5. To save the faxes in memory, see *Forwarding faxes to another fax machine* on page 11-6.)



WARNING



There are high voltage electrodes inside the machine. Before you clean the inside of the machine, make sure you have unplugged the telephone line cord first and then the power cord from the AC power outlet.

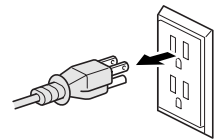

Do not handle the plug with wet hands. Doing this might cause an electrical shock.

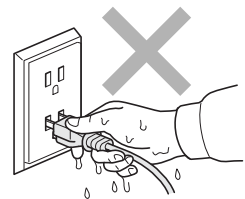

WARNING



After you use the machine, some internal parts are extremely HOT! To prevent injuries, be careful not to put your fingers in the area shown in the illustration.

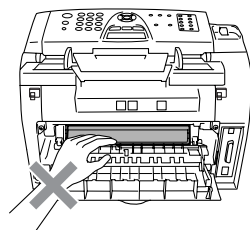
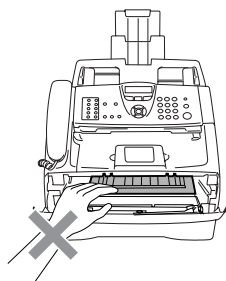

The fuser unit is marked with a caution label. Please do not remove or damage the label.

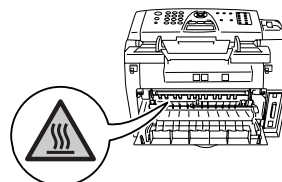

- Use caution when installing or modifying telephone lines. Never touch telephone wires or terminals that are not insulated unless the telephone line has been disconnected at the walljack. Never install telephone wiring during a lightning storm. Never install a telephone wall jack in a wet location.
- This product must be installed near an AC power outlet that is easily accessible. In case of an emergency, you must disconnect the power cord from the AC power outlet to shut off the power completely.
- To reduce the risk of shock or fire, use only a No. 26 AWG or larger telecommunication line cord.

Do not use a vacuum cleaner to clean up scattered toner. Doing this might cause the toner dust to ignite inside the vacuum cleaner, potentially starting a fire. Please carefully clean the toner dust with a dry, lint-free cloth and dispose of it according to local regulations.

CAUTION

Lightning and power surges can damage this product! We recommend that you use a quality surge protection device on the AC power line and on the telephone line, or unplug the cords during a lightning storm.

WARNING

IMPORTANT SAFETY INSTRUCTIONS

When using your telephone equipment, basic safety precautions should always be followed to reduce the risk of fire, electric shock and injury to people, including the following:

1. Do not use this product near water, for example, near a bath tub, wash bowl, kitchen sink or washing machine, in a wet basement or near a swimming pool.
2. Avoid using this product during an electrical storm. There may be a remote risk of electric shock from lightning.
3. Do not use this product to report a gas leak in the vicinity of the leak.
4. Use only the power cord supplied with this machine.

SAVE THESE INSTRUCTIONS

Quick Reference Guide

Sending Faxes

Automatic Transmission

- 1 If it is not illuminated in green, press  (**Fax**).
- 2 Load your document.
- 3 Enter the fax number using One-Touch, Speed-Dial, Search or the dial pad.
- 4 Press **Start**.

Storing numbers

Storing One-Touch Dial numbers

- 1 Press **Menu/Set**, **2, 3, 1**.
- 2 Press the One-Touch key where you want to store the number.



Note

FAX-2820 and FAX-2920 only:
To access One-Touch numbers 11 to 20, hold down **Shift** as you press the One-Touch key.

- 3 Enter the number (up to 20 digits).
Press **Menu/Set**.
- 4 Enter the name up to 15 characters (or leave it blank).
Press **Menu/Set**.
- 5 Press **Stop/Exit**.

Storing Speed-Dial numbers

- 1 Press **Menu/Set**, **2, 3, 2**.
- 2 Using the dial pad, enter a three-digit Speed-Dial location number.
Press **Menu/Set**.
- 3 Enter the number (up to 20 digits).
Press **Menu/Set**.
- 4 Enter the name up to 15 characters (or leave it blank).
Press **Menu/Set**.
- 5 Press **Stop/Exit**.

Dialing operations

One-Touch Dialing / Speed-Dialing

- 1 If it is not illuminated in green, press  (**Fax**).
- 2 Load your document.
- 3 Press the One-Touch key of the number you want to call.



Note

FAX-2820 and FAX-2920 only:
To dial One-Touch numbers 11 to 20, hold down **Shift** as you press the One-Touch key.

—OR—

- Press **Search/Speed Dial**, press #.
Press the three-digit Speed-Dial number.
- 4 Press **Start**.

Using Search

- 1 If it is not illuminated in green, press  (**Fax**).
- 2 Load your document.
- 3 Press **Search/Speed Dial**, and then enter the first letter of the name you're looking for.
- 4 Press ◀ or ▶ to search the memory.
- 5 Press **Start**.

Making copies

Single copy

- 1 Press  (**Copy**) to illuminate it in green.
- 2 Load your document.
- 3 Press **Start**.

Sorting copies using the ADF

- 1 Press  (**Copy**) to illuminate it in green.
- 2 Load your document.
- 3 Use the dial pad to enter the number of copies you want (up to 99).
- 4 Press **Options** and ▲ or ▼ to select *Stack/Sort*.
Press **Menu/Set**.
- 5 Press ▲ or ▼ to select *Sort*.
Press **Menu/Set**.
- 6 Press **Start**.

Table of Contents

1 Introduction

Using this Guide	1-1
Choosing a location	1-2
How to access the complete User's Guide (MFC-7220 and MFC-7225N only)	1-3
To view Documentation (For Windows®)	1-3
How to find Scanning instructions	1-3
To view Documentation (For Macintosh®)	1-4
How to find Scanning instructions	1-4
Control panel overview	1-5
Load document.....	1-7
Using the automatic document feeder (ADF)	1-7
About paper	1-8
Recommended paper	1-8
Choosing acceptable paper.....	1-8
Paper capacity of the paper trays.....	1-9
How to load paper	1-10
To load paper or other media in the paper tray	1-10
To load paper or other media in the manual feed slot.....	1-11
About fax machines	1-12
Custom features	1-12
Do you have Voice Mail on the phone line?	1-12
Why should there be problems?.....	1-12
How can you avoid possible problems?	1-12
Fax tones and handshake	1-13
ECM (Error Correction Mode).....	1-13

2 Getting started

Initial setup	2-1
Setting the Date and Time	2-1
Setting Tone and Pulse dialing mode (For Canada only).....	2-1
Setting the Station ID.....	2-2
General Setup	2-3
Setting the Mode Timer (FAX-2820 and FAX-2920 only)	2-3
Setting the Mode Timer (MFC-7220 and MFC-7225N only).....	2-3
Setting the Paper Type	2-4
Setting the Paper Size	2-4
Setting the Ring Volume	2-5
Setting the Beeper Volume.....	2-5
Setting the Speaker Volume	2-5
Setting the Handset Volume.....	2-6
Choosing the Handset Volume (For Volume Amplify)	2-6
Setting Volume Amplify	2-7
Turning on Automatic Daylight Savings Time.....	2-7
Toner Save	2-7
Sleep Time	2-8
Setting the LCD Contrast.....	2-8

Security	2-9
TX Lock (FAX-2820 and MFC-7220 only)	2-9
Setting up the password	2-9
Changing the TX Lock password.....	2-9
Turning TX Lock on	2-10
Turning TX Lock off	2-10
Memory Security (FAX-2920 and MFC-7225N only).....	2-10
Setting up the password	2-11
Changing the Memory Security password.....	2-11
Turning Memory Security on	2-11
Turning Memory Security off	2-11
Setting Lock	2-12
Setting up the password	2-12
Changing the Setting Lock password	2-13
Turning Setting Lock on.....	2-13
Turning Setting Lock off.....	2-13

3 Setup Send

How to enter Fax mode	3-1
How to dial	3-1
Manual dialing	3-1
One-Touch Dialing.....	3-1
Speed-Dialing	3-2
Search	3-2
Fax Redial	3-3
How to Fax.....	3-3
Faxing from the ADF	3-3
Automatic transmission	3-3
Manual transmission.....	3-3
Sending a fax at the end of a conversation	3-4
Out of Memory message	3-4
Basic sending operations.....	3-4
Sending faxes using multiple settings	3-4
Contrast	3-5
Fax Resolution.....	3-5
Dual Access.....	3-6
Real Time Transmission.....	3-6
Broadcasting.....	3-7
Checking job status	3-8
Canceling a fax in progress	3-8
Canceling a scheduled job	3-8
Advanced sending operations	3-9
Composing the electronic Cover Page	3-9
Composing your own comments	3-9
Cover page for the next fax only.....	3-9
Send a cover page for all faxes	3-10
Using a printed cover page.....	3-10
Overseas Mode	3-10
Delayed Fax	3-11
Delayed Batch Transmission	3-11
Setting up Polled Transmit	3-12

4 Setup Receive

Basic receiving operations.....	4-1
Choosing the Receive Mode	4-1
To select or change your Receive Mode	4-2
Setting the Ring Delay	4-2
Setting the F/T Ring Time (Fax/Tel mode only).....	4-3
Easy Receive.....	4-3
Printing a reduced incoming fax (Auto Reduction)	4-4
Receiving a fax at the end of a conversation.....	4-4
Advanced receiving operations.....	4-5
Printing a fax from the memory	4-5
Setting the Print Density	4-5
Polling.....	4-5
Setting up Polling Receive.....	4-5
Setting up Sequential Polling Receive.....	4-6

5 Quick-Dial numbers and dialing options

Storing numbers for easy dialing	5-1
Storing One-Touch numbers	5-1
Storing Speed-Dial numbers	5-2
Changing One-Touch / Speed-Dial numbers	5-2
Setting up Groups for Broadcasting	5-3
Dialing options	5-4
Access codes and credit card numbers.....	5-4
Pause	5-4
Tone or Pulse (For Canada only)	5-4

6 Remote Fax Options

Setting Remote Fax Options.....	6-1
Setting up Fax Forwarding	6-1
Programming your pager number.....	6-2
Setting Fax Storage.....	6-2
PC Fax Receive (MFC-7220 and MFC-7225N only)	6-3
Turning off Remote Fax Options	6-4
Changing Remote Fax Options (MFC-7220 and MFC-7225N only).....	6-4
Setting your Remote Access Code.....	6-5
Remote Retrieval.....	6-5
Using your Remote Access Code.....	6-5
Remote commands	6-6
Retrieving fax messages	6-7
Changing your Fax Forwarding number	6-7

7 Printing reports

Fax settings and activity	7-1
Customizing the Transmission Verification Report.....	7-1
Setting the Journal Period	7-2
Printing reports	7-2
How to print a report.....	7-2

8 Making copies

Using the machine as a copier	8-1
Enter Copy mode.....	8-1
Making a single copy	8-1
Making multiple copies	8-2
Stop copying	8-2
Using the temporary Copy key	8-2
Using the Options key	8-3
Enlarging or reducing the image copied	8-4
Quality	8-5
Sorting copies using the ADF	8-5
Making N in 1 copies (Page Layout).....	8-6
Changing the default copy settings.....	8-7
Quality	8-7
Adjusting contrast	8-7
Out of Memory message	8-7

9 Software and Network Features (MFC-7220 and MFC-7225N only)

9-1

10 Important information

Standard telephone and FCC Notices	
These notices are in effect on models sold and used in the United States only.....	10-1
Federal Communications Commission (FCC) Declaration of Conformity (USA only)	10-2
Important	10-2
Important - about the interface cable.....	10-2
Industry Canada Compliance Statement (Canada only)	10-2
Disconnect device	10-3
LAN connection (MFC-7225N only).....	10-3
International ENERGY STAR® Compliance Statement.....	10-3
Laser safety	10-3
FDA regulations.....	10-3
Important safety instructions.....	10-4
Trademarks	10-5

11 Troubleshooting and routine maintenance

Troubleshooting	11-1
Error messages	11-1
Checking if the machine has faxes in its memory	11-6
Forwarding faxes to another fax machine	11-6
Transferring faxes to your PC (MFC-7220 and MFC-7225N only)	11-6
Document jams.....	11-7
Document was not inserted or fed properly, or was too long	11-7
Paper jams	11-7
Paper is jammed inside the machine.....	11-7
Paper is jammed at the back of the machine	11-9
Paper is jammed inside the drum unit and toner cartridge assembly	11-10

If you are having difficulty with your machine	11-11
Improving the print quality	11-16
Cleaning the drum unit	11-17
Compatibility	11-20
Packing and shipping the machine	11-20
Routine maintenance.....	11-21
Cleaning the outside of the machine	11-21
Cleaning the scanner glass	11-22
Cleaning the laser scanner window.....	11-22
Cleaning the corona wire.....	11-24
Replacing the toner cartridge (TN-350)	11-24
How to replace the toner cartridge	11-25
Replacing the drum unit (DR-350).....	11-27
Machine Information	11-29
Checking the Serial Numbers.....	11-29
Checking the Page Counters.....	11-29
Checking the Drum Life	11-29

A Appendix A

Setting up telephone services.....	A-1
Distinctive Ring.....	A-1
What does your telephone company's 'Distinctive Ring' do?	A-1
What does Brother's 'Distinctive Ring' do?.....	A-1
Do you have Voice Mail?.....	A-1
Before you choose the ring pattern to register	A-2
Registering the Distinctive Ring pattern	A-2
Turning off the Distinctive Ring.....	A-2
Caller ID.....	A-3
Viewing Caller ID List	A-3
Printing Caller ID List.....	A-3
Call Waiting	A-4
Advanced receiving operations.....	A-4
Operation from extension telephones.....	A-4
For Fax/Tel mode only.....	A-4
Using a cordless external handset	A-5
Changing the remote codes	A-5
Connecting an external device to your machine.....	A-5
Connecting an external telephone.....	A-5
Connecting an external telephone answering device (TAD)	A-5
Sequence	A-5
Connections	A-6
Recording outgoing message (OGM) on an external TAD.....	A-7
Special line considerations	A-7
Roll over phone lines	A-7
Two-line phone system.....	A-7
Converting telephone wall outlets.....	A-8
Installing machine, external two-line TAD and two-line telephone	A-8
Multi-line connections (PBX)	A-9
If you are installing the machine to work with a PBX.....	A-9
Custom features on your phone line.....	A-9

B Appendix B

On-screen programming	B-1
Menu table	B-1
Memory storage.....	B-1
Navigation keys	B-2
Entering Text	B-11
Inserting spaces	B-11
Making corrections	B-11
Repeating letters	B-11
Special characters and symbols	B-11

G Glossary G-1

S Specifications

Product description	S-1
General	S-1
Print media.....	S-3
Copy	S-3
Fax.....	S-4
Scanner (MFC-7220 and MFC-7225N only).....	S-5
Printer	S-5
Interfaces	S-6
Download the optional software from the Brother Web Site (FAX-2820 and FAX-2920 users only).....	S-6
At the same time, you can download the manual for setting up and using the PC-Fax software.	S-6
Computer requirements	S-7
Consumable items	S-8
Network (LAN) (MFC-7225N only).....	S-9
Optional External Wireless Print/Scan Server (NC-2200w) (MFC-7220 and MFC-7225N only)	S-10
Optional External Print Server (NC-2100p) (MFC-7220 and MFC-7225N only)	S-11

I Index I-1

R Remote Retrieval Access card R-1

1

Introduction

Using this Guide

Throughout this Guide you will see special symbols alerting you to important warnings, notes and actions. Special fonts identify keys you should press, messages that appear on the LCD, and important points or related topics.

Bold

Bold typeface identifies specific keys on the machine's control panel.

Italics

Italicized typeface emphasizes an important point or refers you to a related topic.

`Courier`

Courier type face identifies the messages on the LCD of the machine.



Warnings tell you what to do to prevent possible personal injury.



Electrical Hazard icons alert you to a possible electrical shock.



Hot Surface icons warn you not to touch machine parts that are hot.



Cautions specify procedures you must follow or avoid to prevent possible damage to the machine or other objects.



Improper Setup icons alerts you to devices and operations that are not compatible with the machine.



Notes tell you how you should respond to a situation that may arise or give tips about how the operation works with other features.

Choosing a location

Place your machine on a flat, stable surface that is free of vibration and shocks, such as a desk. Put the machine near a telephone wall jack and a standard, grounded AC power outlet. Choose a location where the temperature remains between 50°F and 90.5°F (10°C and 32.5°C).

! CAUTION

- Avoid placing your machine in a high-traffic area.
- Do not place the machine near heaters, air conditioners, water, chemicals, or refrigerators.
- Do not expose the machine to direct sunlight, excessive heat, moisture, or dust.
- Do not connect your machine to an AC power outlet controlled by wall switches or automatic timers.
- Disruption of power can wipe out information in the machine's memory.
- Do not connect your machine to an AC power outlet on the same circuit as large appliances or other equipment that might disrupt the power supply.
- Avoid interference sources, such as speakers or the base units of cordless phones.



How to access the complete User's Guide (MFC-7220 and MFC-7225N only)

This User's Guide does not contain all the information about the machine such as how to use the advanced features of the Fax, Printer, Scanner, PC Fax and Network. When you are ready to learn detailed information about these operations, read the complete User's Guide located in the 'Documentation' section of the CD-ROM.



Note

Network is not available for MFC-7220.

To view Documentation (For Windows®)

From the **Start** menu, select **Brother, MFL Pro Suite MFC-XXXX** (where XXXX is your model name) from the Programs Group and then select **User's Guide**.

—OR—

- 1 Turn on your PC. Insert the Brother CD-ROM labeled Windows® into your CD-ROM drive.
- 2 If the model name screen appears, click your model name.
- 3 If the language screen appears, click your language.

The CD-ROM main menu will appear.

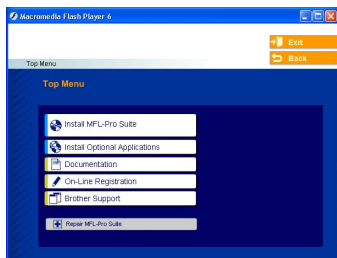

Note

If this window does not appear, use Windows® Explorer to run the setup.exe program from the root directory of the Brother CD-ROM.

- 4 Click **Documentation**.
- 5 Click the documentation you want to read.
 - **Quick Setup Guide:**
Setup and Software Installation Instructions
 - **User's Guide (2 or 3 manuals):**
User's Guide for stand-alone operations, Software User's Guide and Network* User's Guide
*MFC-7225N only
 - **PaperPort® User's Guide:**
Document Management Software

How to find Scanning instructions

There are several ways you can scan documents. You can find the instructions as follows:

Software User's Guide:

- How to scan using Windows® in Chapter 2 (For Windows® 98/98SE/Me/2000 Professional/XP/Windows NT® Workstation Version 4.0)
- Using ControlCenter2.0 in Chapter 3 (For Windows® 98/98SE/Me/2000 Professional/XP/Windows NT® Workstation Version 4.0)
- Network Scanning in Chapter 6 (Optional NC-2200w external wireless print/scan server required)

PaperPort® User's Guide

- Instructions for scanning directly from ScanSoft® PaperPort®

To view Documentation (For Macintosh®)

- 1 Turn on your Macintosh®. Insert the Brother CD-ROM labeled Macintosh® into your CD-ROM drive. The following window will appear.

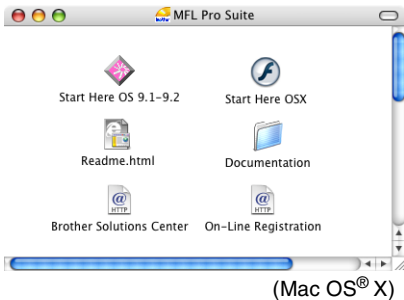

- 2 Double-click the **Documentation** icon.
- 3 The select Language screen appears, double-click your language.
- 4 Click the documentation you want to read.
 - **Quick Setup Guide:**
Setup and Software Installation Instructions
 - **User's Guide (2 or 3 manuals):**
User's Guide for stand-alone operations, Software User's Guide and Network* User's Guide

*MFC-7225N only

How to find Scanning instructions

There are several ways you can scan documents. You can find the instructions as follows:

Software User's Guide:

- *Scanning from a Macintosh®* on page 7-13. (For Mac OS® 9.1 - 9.2/Mac OS® X 10.2.4 or greater)
- *Using ControlCenter2.0 (For Mac OS® X 10.2.4 or greater)* on page 7-24
- Network Scanning on page 7-19 (For Mac OS® X 10.2.4 or greater)
(Optional NC-2200w external wireless print/scan server required)

Presto!® PageManager® User's Guide

- Instructions for scanning directly from Presto!® PageManager®

Control panel overview

FAX-2820 and FAX-2920 have the same keys.

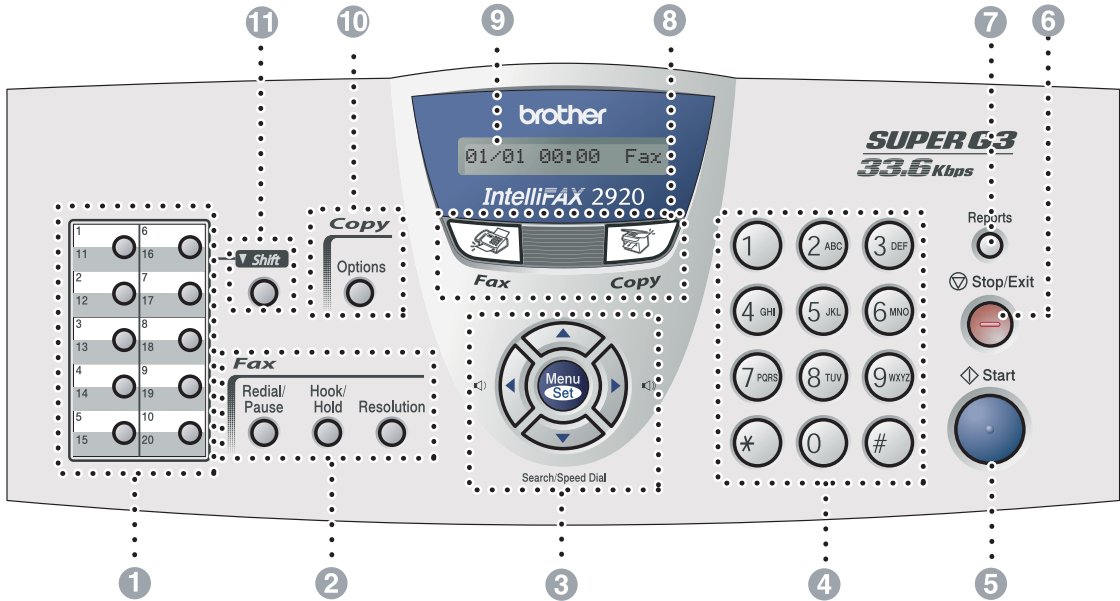

MFC-7220 and MFC-7225N have the same keys.

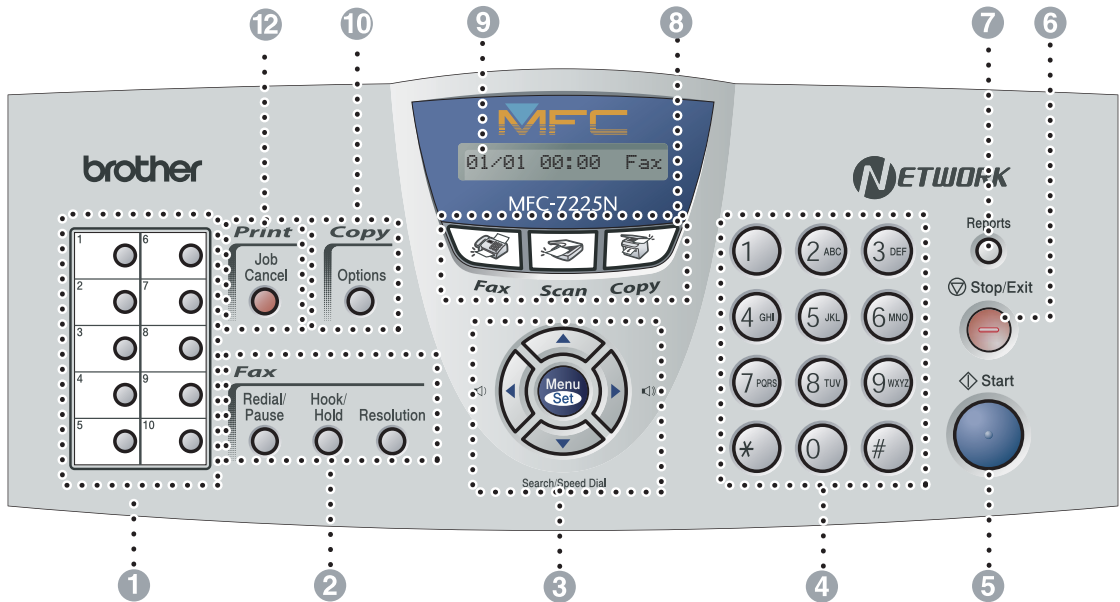

1 One-Touch Keys

These 10 keys give you instant access to 10 (MFC-7220 and MFC-7225N) or 20 (FAX-2820 and FAX-2920) previously stored dial numbers.

2 Fax and telephone keys:**Redial/Pause**

Redials the last number you called. It also inserts a pause in quick dial numbers.

Hook/Hold

Lets you dial telephone and fax numbers without lifting the handset.

—OR—

Lets you place telephone calls on hold.

Resolution

Sets the resolution when you send a fax.

3 Navigation keys:**Menu/Set**

The same key is used for Menu and Set operations.

Lets you access the Menu to program and store your settings in the machine.

Volume keys

When using the handset, listening to the speaker in Fax mode or on standby, you can press these keys to adjust the volume.

▼ Search/Speed Dial

Lets you look up numbers that are stored in the dialing memory. It also lets you dial stored numbers by pressing # and a three-digit number.



Press to scroll forward or backward to a menu selection.



Press to scroll through the menus and options.

4 Dial Pad

Use these keys to dial telephone or fax numbers and as a keyboard for entering information into the machine.

The # key lets you temporarily switch the dialing mode during a telephone call from Pulse to Tone (For Canada only).

5 Start

Lets you start sending faxes or making copies.

6 Stop/Exit

Stops an operation or exits from the menu.

7 Reports

Print the Transmission Verification Report, Help List, Quick-Dial List, Fax Journal, User Settings and Network Configuration*. (*MFC-7225N only).

8 Mode keys:**Fax**

Lets you access Fax mode.

**Scan**

(MFC-7220 and MFC-7225N only)

Lets you access Scan mode.

**Copy**

Lets you access Copy mode.

9 Liquid Crystal Display (LCD)

Displays messages on the screen to help you set up and use your machine.

10 Copy key (Temporary settings):**Options**

You can quickly and easily select temporary settings for copying.

11 Shift (FAX-2820 and FAX-2920 only)

To access One-Touch numbers 11 to 20, hold down **Shift** as you press the One-Touch key.

12 Printer key: (MFC-7220 and MFC-7225N only)**Job Cancel**

You can cancel a print job and clear the printer memory.

Load document

You can send a fax, make copies, and scan from the ADF (automatic document feeder).

Note

The Scan feature is not available for FAX-2820 and FAX-2920.

Using the automatic document feeder (ADF)

FAX-2820 and MFC-7220:

The ADF can hold up to 20 pages, feeding each one individually through the machine. Use standard 20 lb (80 g/m²) paper and always fan the pages before putting them in the ADF.

FAX-2920 and MFC-7225N:

The ADF can hold up to 30 pages, if you stagger the pages and meet the following conditions:

Temperature: 68° F - 86° F (20° - 30°C)

Humidity: 50% - 70%

Paper: Xerox 4200 or Xerox 4024 (20 lb/Letter)

CAUTION

- **DO NOT** use paper that is curled, wrinkled, folded, ripped, stapled, paper-clipped, pasted or taped.
- **DO NOT** use cardboard, newspaper or fabric.

- Make sure documents written with ink are completely dry.
- Documents to be faxed must be from 5.8 to 8.5 in. (147.3 to 215.9 mm) wide and 3.9 to 14 in. (100 to 356 mm) long.

- 1 Pull out the ADF document support.



- 2 Fan the pages well. Make sure you put the documents **face down, top edge first** in the ADF until you feel them touch the feed roller.
- 3 Adjust the paper guides to fit the width of your documents.

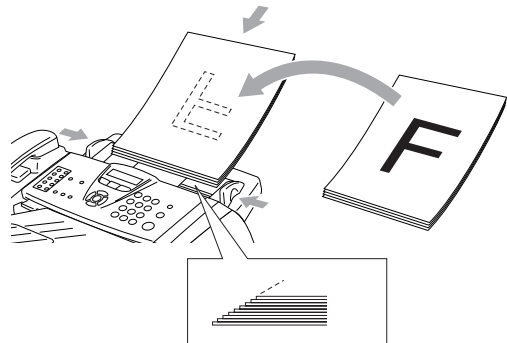

CAUTION

DO NOT pull on the document while it is feeding.

About paper

Recommended paper

To get the best print quality, we suggest using the following paper.

Paper Type	Item
Plain paper	Xerox 4200DP 20 lb
	Hammermill Laser Paper 24 lb
	(Xerox Premier 80 g/m ²) (Xerox Business 80 g/m ²) (M-real DATACOPY 80 g/m ²) (IGEPA X-Press 80 g/m ²)
	(Xerox Recycled Supreme)
Recycled paper	(Xerox Recycled Supreme)
Transparency	3M CG 3300
Labels	Avery laser label #5160 (Avery laser label L7163)

- Use paper that is made for plain-paper copying.
- Use paper that is 20 to 24 lb (75 to 90 g/m²).
- Use neutral paper. Do not use acidic or alkaline paper.
- Use long-grain paper.
- Use paper with a moisture content of approximately 5%.

Choosing acceptable paper

We recommend that you test paper (especially special sizes and types of paper) on the machine before purchasing large quantities.

For optimum printing, use a recommended type of paper, especially for plain paper and transparencies. For more information on paper specifications, call your nearest authorized sales representative or the place where you purchased your machine.

- Use labels or transparencies that are designed for use in laser printers.
- If you are using special paper and the machine has problems feeding it from the paper tray, try again using the manual feed slot.
- You can use recycled paper in this machine.

! CAUTION

Do not use the following types of paper or envelopes; they may cause a paper jam and damage your machine.

■ Do not use:

- Inkjet paper;
- Coated paper, such as vinyl coated paper;
- Pre-printed or highly textured paper, or paper with an embossed letterhead;
- Label sheets that have had any labels removed;
- Paper that has been previously printed on;
- Paper that cannot be arranged uniformly when stacked;
- Paper that is made with a short grain;
- Damaged, curled, wrinkled, or irregularly shaped paper.

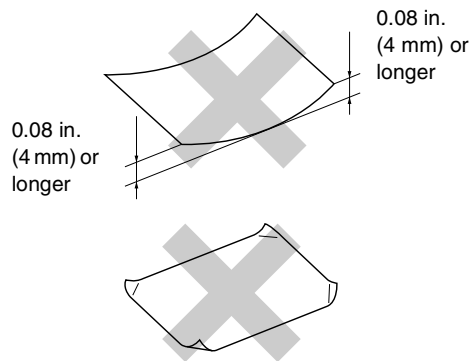

■ Do not use:

- Envelopes that are of a baggy construction;
- Envelopes that are embossed (have raised writing on them);
- Envelopes that have clasps on them;
- Envelopes that are not sharply creased;
- Envelopes that are pre-printed on the inside.

Paper capacity of the paper trays

	Paper size	Paper types	No. of sheets
Paper tray	A4, Letter, Legal, Executive, A5, A6, B5 and B6	Plain paper, Recycled paper	up to 250
		Transparency	up to 10
Manual feed slot	Width: 2.75 - 8.5 in. (69.9 - 215.9 mm) Length: 4.56 - 16 in. (116 - 406.4 mm)	Plain paper, Recycled paper, Bond paper, Envelope, Labels and Transparency	1

How to load paper

To load paper or other media in the paper tray

- 1 Pull the paper tray completely out of the machine.

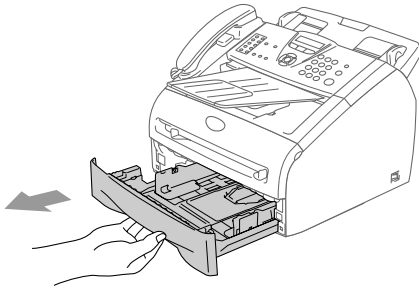

- 2 While pressing the paper guide release lever, slide the adjusters to fit the paper size. Check that the guides are firmly in the slots.

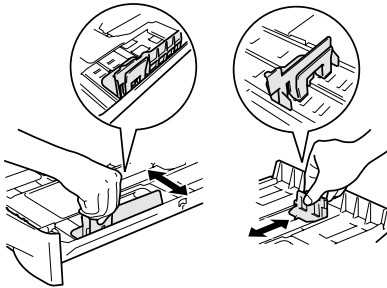

Note

For Legal size paper, press in the inside latches and pull out the back of the paper tray.

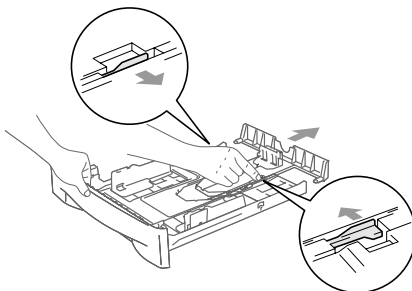

- 3 Fan the stack of paper well to avoid paper jams and mis-feeds.

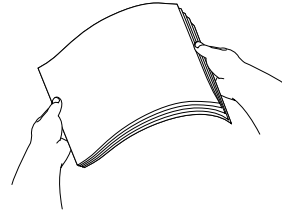

- 4 Put paper in the paper tray.

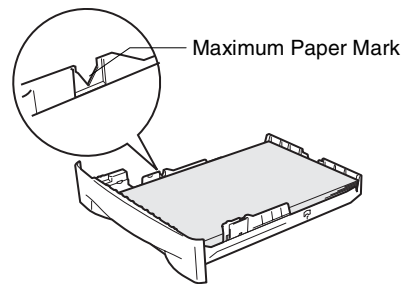

- 5 Put the paper tray firmly back in the machine and unfold the output paper tray support flap before you use the machine.

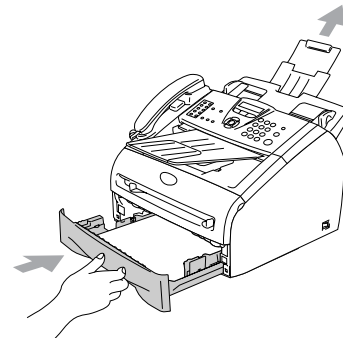

Output Paper Tray Support Flap

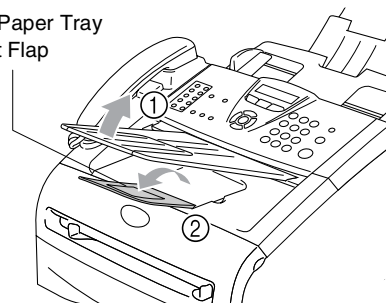

 **Note**

When you put paper in the paper tray, please remember the following:

- Check that the paper is flat in the tray and below the maximum paper mark, and that the paper guides are touching the sides of the paper stack.
- The side to be printed on must be face down.

To load paper or other media in the manual feed slot

You can load envelopes and special print media one at a time into this slot. Use the manual feed slot to print or copy on labels, envelopes or thicker paper.

- 1 Slide the paper guides to fit the paper size.

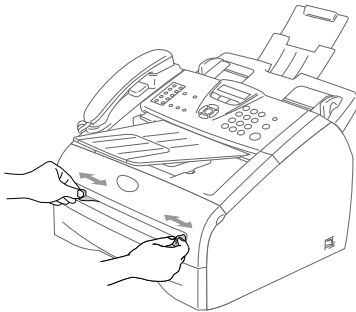

- 2 Using both hands put the one sheet of paper in the manual feed slot until you feel the front edge of the paper touch the paper feed roller. Let go of the paper when you feel the machine feed the paper in a short distance.



 **Note**

When you put paper in the manual feed slot, please remember the following:

- The side to be printed on must be face up.
- Put the leading edge (top of the paper) in first and push it gently into the slot.
- Make sure that the paper is straight and in the proper position on the manual feed slot. If it is not, the paper may not be fed properly, resulting in a skewed printout or a paper jam.
- Do not put more than one sheet or envelope in the manual feed slot at a time or you may cause the machine to jam.

About fax machines

Custom features

Do you have Voice Mail on the phone line?

If you have Voice Mail on the phone line where you will install your new machine, *there is a strong possibility that Voice Mail and the machine may conflict with each other while receiving incoming calls.*

Why should there be problems?

Since both the machine and Voice Mail will pick up the call, after the number of rings you have set, each of them has the ability to keep the other from receiving calls.

For example, if Voice Mail is set to answer after two rings and your machine is set to answer after four, Voice Mail will stop your machine from receiving faxes.

If you set Voice Mail and the Brother machine to answer after the same number of rings, there is no way of knowing which one will answer first. It is important to remember that neither Voice Mail nor the machine can pass the call back to the other after the call has been answered.

How can you avoid possible problems?

A very good way to avoid problems like the one mentioned, *is to get a second phone number on your present phone line.*

Many people with Voice Mail choose an alternative service, which is called “Distinctive Ring”, and they are very satisfied with it.

(See *Distinctive Ring* on page A-1.)

Another way to avoid possible problems is to replace Voice Mail with an answering machine. Your Brother machine is designed to work with an answering machine or TAD (telephone answering device).

(See *Connecting an external telephone answering device (TAD)* on page A-5.)

Fax tones and handshake

When someone is sending a fax, the fax machine sends fax calling tones (CNG tones). These are quiet, intermittent beeps every 4-seconds. You'll hear them after you dial and press **Start** and they will continue for about 60 seconds after dialing. During that time, the sending machine must begin the "handshake" or connection with the receiving machine.

Each time you use automatic procedures to send a fax, you are sending CNG tones over the phone line. You will soon learn to listen for these quiet beeps each time you answer a phone on your fax line, so you will know if you are receiving a fax message.

The receiving fax responds with fax receiving tones, which are loud, chirping sounds. A receiving fax chirps for about 40 seconds over the phone line, and the LCD shows *Receiving*.

If your machine is set to the Fax Only mode, it will answer every call automatically with fax receiving tones. If the other person hangs up, your machine will continue to send the "chirps" for about 40 seconds, and the LCD continues to show *Receiving*. To cancel receiving, press **Stop/Exit**.

The fax 'handshake' is the time in which the sending machine's CNG tones and the receiving machine's "chirps" overlap. This must be for at least 2 to 4 seconds, so both machines can understand how each is sending and receiving the fax. The handshake cannot begin until the call is answered, and the CNG tones only last for about 60 seconds after the number is dialed. So it is important for the receiving machine to answer the call in as few rings as possible.

ECM (Error Correction Mode)

The Error Correction Mode (ECM) is a way for the machine to check a fax transmission while it is in progress. If the machine detects errors during fax transmission, it resends the pages of the fax that had an error. ECM transmissions are only possible between fax machines that both have this feature. If they do, you may send and receive fax messages that are continuously being checked by the machine.

If this feature stops working, delete your faxes from the memory.

Initial setup

Setting the Date and Time

When the machine is not in use it will display the date and time. If you set up the Station ID the date and time displayed by your machine will be printed on every fax you send. If there is a power failure, you may have to reset the date and time. No other settings will be affected.

- 1 Press **Menu/Set**, **0**, **2**.

2.Date/Time

- 2 Enter the last two digits of the year.

Press **Menu/Set**.

- 3 Enter two digits for the month.

Press **Menu/Set**.

(For example, enter 09 for September, or 10 for October.)

- 4 Enter two digits for the day.

Press **Menu/Set**.

(For example, enter 06 for 6th.)

- 5 Enter the time in 24-Hour format.

Press **Menu/Set**.

(For example, enter 15:25 for 3:25 P.M.)

- 6 Press **Stop/Exit**.

The LCD now shows the date and time whenever the machine is idle in Fax mode.

When the machine is in Sleep mode, the LCD shows *Sleep*. (See *Sleep Time* on page 2-8.)

Setting Tone and Pulse dialing mode (For Canada only)

- 1 Press **Menu/Set**, **0**, **4**.

4.Tone/Pulse

- 2 Press **▲** or **▼** to select *Pulse* (or *Tone*).

Press **Menu/Set**.

- 3 Press **Stop/Exit**.

Setting the Station ID

You should store your name or company name and fax number so they print on all fax pages you send.

- 1 Press **Menu/Set**, **0**, **3**.

3.Station ID

- 2 Enter your fax number (up to 20 digits).
Press **Menu/Set**.

- 3 Enter your telephone number (up to 20 digits).

Press **Menu/Set**.

(If the telephone number and fax number are the same, enter the same number again.)



Note

- You cannot enter a hyphen in the number. To enter a space press ► once between numbers.
- The telephone number you enter is only used for Cover Page features. (See *Composing the electronic Cover Page* on page 3-9.)



- 4 Use the dial pad to enter your name (up to 20 characters).
(See *Entering Text* on page B-11).
Press **Menu/Set**.



- 5 Press **Stop/Exit**.



Note

If the Station ID has already been programmed, the LCD will ask you to press **1** to make a change or **2** to exit without changing.

NOTICE (For USA)

The Telephone Consumer Protection Act of 1991 makes it unlawful for any person to use a computer or electronic device to send any message via a telephone fax machine unless such messages clearly contain, in a margin at the top or bottom of each transmitted page, or on the first page of the transmission, the date and time it is sent and an identification of the business or other entity or other individual sending the message and the telephone number of the sending machine or such business, other entity or individual.

To program this information into your machine, see *Setting the Date and Time* on page 2-1 and *Setting the Station ID* on page 2-2.

General Setup

Setting the Mode Timer (FAX-2820 and FAX-2920 only)

The machine has two temporary mode keys on the control panel: Fax and Copy. You can change the number of seconds or minutes the machine takes after the last Copy operation before it returns to Fax mode. If you select **Off**, the machine stays in the mode you used last.

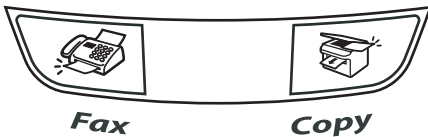

- 1 Press **Menu/Set**, 1, 1.
- 2 Press **▲** or **▼** to select 0 Sec, 30 Secs, 1 Min, 2 Mins, 5 Mins or Off.
 Press **Menu/Set**.
- 3 Press **Stop/Exit**.

Setting the Mode Timer (MFC-7220 and MFC-7225N only)

The machine has three temporary mode keys on the control panel: Fax, Scan and Copy. You can change the number of seconds or minutes the machine takes after the last Scan or Copy operation before it returns to Fax mode. If you select **Off**, the machine stays in the mode you used last.



- 1 Press **Menu/Set**, 1, 1.
- 2 Press **▲** or **▼** to select 0 Sec, 30 Secs, 1 Min, 2 Mins, 5 Mins or Off.
 Press **Menu/Set**.
- 3 Press **Stop/Exit**.

Setting the Paper Type

To get the best print quality, set the machine for the type of paper you are using.

- 1 Press **Menu/Set, 1, 2.**

2.Paper Type

- 2 Press ▲ or ▼ to select **Plain, Thin, Thick, Thicker, Transprncy (Transparency) or Recycled (Recycled Paper).**

Press **Menu/Set.**

- 3 Press **Stop/Exit.**



Note

- The machine ejects paper with printed surfaces face down onto the output paper tray in the front of the machine. When you use transparencies or labels, remove each sheet immediately to prevent smudging or paper jams.
 - You can select **Transprncy (Transparency)** in Step 2 only if **Letter, Legal** or **A4** paper size was selected as the paper size. (**Menu/Set, 1, 3**). (See *Setting the Paper Size* on this page.)
-

Setting the Paper Size

You can use eight sizes of paper for printing copies: **Letter, Legal, A4, B5, A5, B6, A6** and **Executive** and three sizes for printing faxes: **Letter, Legal** and **A4**. When you change the size of paper you load in the paper tray, you will need to change the paper size setting at the same time so your machine can fit an incoming fax or a reduced copy on the page.



Note

If you selected **Transprncy (Transparency)** as the paper type (**Menu/Set, 1, 2**) you will only be able to select **Letter, Legal** or **A4** size paper in Step 2.

- 1 Press **Menu/Set, 1, 3.**

3.Paper Size

- 2 Press ▲ or ▼ to select **Letter, Legal, A4, A5, A6, B5, B6** or **Executive.**

Press **Menu/Set.**

- 3 Press **Stop/Exit.**

Setting the Ring Volume

You can turn the ring **OFF** or you can select the ring volume level.

- 1 Press **Menu/Set**, **1**, **4**, **1**.

1.Ring

- 2 Press **▲** or **▼** to select **Low**, **Med**, **High** or **Off**.

Press **Menu/Set**.

- 3 Press **Stop/Exit**.

—OR—

You can adjust the ring volume when your machine is idle (not being used).

In  mode (Fax), press **◀** or **▶** to adjust the volume level. Every time you press these keys, the machine will ring so you can hear the active setting as the LCD shows it. The volume changes with each key press. The new setting will stay until you change it again.

Setting the Beeper Volume

You can change the beeper volume. The default setting is **Med**. When the beeper is on, the machine will beep when you press a key, make a mistake, or after you sent or received a fax.

- 1 Press **Menu/Set**, **1**, **4**, **2**.

2.Beeper

- 2 Press **▲** or **▼** to select **Low**, **Med**, **High** or **Off**.

Press **Menu/Set**.

- 3 Press **Stop/Exit**.

Setting the Speaker Volume

You can adjust the machine's one-way speaker volume.

- 1 Press **Menu/Set**, **1**, **4**, **3**.

3.Speaker

- 2 Press **▲** or **▼** to select **Low**, **Med**, **High** or **Off**.

Press **Menu/Set**.

- 3 Press **Stop/Exit**.

—OR—

In Fax mode , you can adjust the speaker volume by pressing **Hook/Hold**, and then selecting a speaker volume level.

Press **◀** or **▶** to adjust the volume level. The LCD shows the setting you are choosing. Each key press changes the volume to the next level. The new setting will remain until you change it again.

Setting the Handset Volume

- 1 Press **Menu/Set**, 1, 4, 4.

4.Handset

- 2 Press ▲ or ▼ to select **High** or **Low**.
Press **Menu/Set**.

- 3 Press **Stop/Exit**.

—OR—

You can adjust the handset volume any time you are talking on the telephone. There are two handset volume levels, **Low** and **High**. The default setting is **Low**.

Press ◀▶ or ▶▶ to adjust the volume level. The LCD shows the setting are choosing. The new setting will remain until you change it again.

Choosing the Handset Volume (For Volume Amplify)

Before you begin to use the machine, you must decide if you need to set the handset volume to **Vol Amplify:On** for a user who is hearing-impaired. The **AMPLIFY** volume level complies with FCC standard.

Vol Amplify:Off

This default setting is appropriate if none of the users are hearing-impaired. During a conversation, users can press ◀▶ or ▶▶ on the control panel to adjust the volume the two volume levels. When the handset is replaced, the handset volume will remain until you change it again.

Vol Amplify:On—Temporary

This setting is appropriate if some of the users are hearing-impaired. During a conversation, users can press ◀▶ or ▶▶ on the control panel to adjust the three volume levels.

Vol Amplify:On—Permanent

Choose **Vol Amplify:On—Permanent** if all of the users are hearing-impaired. During conversation, users can press ◀▶ or ▶▶ on the control panel to adjust the three volume levels. When the handset is replaced, the handset volume returns to the default setting of **Volume Amplify**.



Note

When you press ◀▶ or ▶▶ on the control panel to adjust the volume, the LCD shows the setting you are choosing. Each key press changes the volume to the next level.



WARNING

It is important that you do NOT choose **Permanent unless ALL the users are hearing-impaired.** Otherwise, the default setting of **Volume Amplify** may damage the hearing of some users.

Setting Volume Amplify

Please carefully read *Choosing the Handset Volume (For Volume Amplify)* on page 2-6 before you do the following steps;

- 1 Press **Menu/Set**, **1**, **4**, **5**.
- 2 If none of the users are hearing-impaired, press **▲** or **▼** to select `Vol Amplify:Off`, and then press **Menu/Set** and go to Step 4.
 —OR—
 If some or all of the users are hearing-impaired, select `Vol Amplify:On`, and then press **Menu/Set**.
- 3 If all the users are hearing-impaired, press to select `Permanent`, and then press **Menu/Set**.
 —OR—
 If only some or all of the users are hearing-impaired, select `Temporary`, and then press **Menu/Set**.
- 4 Press **Stop/Exit**.

Turning on Automatic Daylight Savings Time

You can set the machine to change automatically for Daylight Savings Time. It will reset itself forward one hour in the Spring and backward one hour in the Fall. Make sure you have set the correct date and time in the `Date/Time` setting.

- 1 Press **Menu/Set**, **1**, **5**.
- 2 Press **▲** or **▼** to select `On` (or `Off`).
 Press **Menu/Set**.
- 3 Press **Stop/Exit**.

Toner Save

You can conserve toner using this feature. When you set Toner Save to `On`, print appears lighter. The default setting is `Off`.

- 1 Press **Menu/Set**, **1**, **6**, **1**.
- 2 Press **▲** or **▼** to select `On` (or `Off`).
 Press **Menu/Set**.
- 3 Press **Stop/Exit**.

Sleep Time

Setting the Sleep Time reduces power consumption by turning off the fuser inside the machine while it is idle. You can choose how long the machine is idle (from 00 to 99 minutes) before it goes into sleep mode. The timer is automatically reset when the machine receives a Fax or PC data or makes a copy. The factory setting is 05 minutes. While the machine is in sleep mode you will see *Sleep* on the LCD. If you try to print or copy in sleep mode, there will be a short delay while the fuser warms up to its working temperature.

- 1 Press **Menu/Set**, **1**, **6**, **2**.

2.Sleep Time

- 2 Use the dial pad to enter the length of time the machine is idle before it goes into sleep mode (00 to 99).

—OR—

To turn *off* sleep mode, press **Start** and **Options** simultaneously.

Press **▲** or **▼** to select *Off*.

Press **Menu/Set**.

- 3 Press **Stop/Exit**.



Note

- If you want to turn off sleep mode, press **Start** and **Options** simultaneously in Step 2.
- If the machine is in sleep mode when you change the Sleep Time, the new setting will take effect the next time the machine copies, prints or is turned off and on.

Setting the LCD Contrast

You can change the contrast to help the LCD look lighter or darker.

- 1 Press **Menu/Set**, **1**, **7**.

7.LCD Contrast

- 2 Press **▲** or **▼** to select *Light* or *Dark*.

Press **Menu/Set**.

- 3 Press **Stop/Exit**.

Security

You can set up your machine with multiple levels of security using TX Lock (FAX-2820 and MFC-7220 only), Memory Security (FAX-2920 and MFC-7225N only) and Setting Lock.

TX Lock (FAX-2820 and MFC-7220 only)

TX Lock lets you prevent unauthorized access to the machine. You will not be able to continue to schedule Delayed Faxes or Polling jobs. However, any pre-scheduled Delayed Faxes will be sent even if you turn on TX Lock, so they won't be lost.

While TX Lock is on, the following operations are available:

- Receiving faxes
- Fax Forwarding
(if Fax Forwarding was already on)
- Remote Retrieval
(if Fax Storage was already on)
- Paging (if Paging was already on)
- PC Fax Receive (MFC-7220 only)
(if PC Fax Receive was already on)
- Receiving telephone calls

While TX Lock is on, the following operations are NOT available:

- Sending faxes
- Making telephone calls
- Copying
- PC printing (MFC-7220 only)
- Scanning (MFC-7220 only)

Setting up the password



Note

- If you have already set the password, you will not need to set it again.
- If you forget the TX Lock password, please call Brother Customer Service. (See *Brother numbers* on page i.)

- 1 Press **Menu/Set**, **1**, **8**, **1**.

1 .TX Lock

- 2 Enter a four-digit number for the password.

Press **Menu/Set**.

If you are entering the password for the first time, the LCD shows *Verify*.

- 3 Re-enter the password.

Press **Menu/Set**.

- 4 Press **Stop/Exit**.

Changing the TX Lock password

- 1 Press **Menu/Set**, **1**, **8**, **1**.

1 .TX Lock

- 2 Press **▲** or **▼** to select *Set Password*.

Press **Menu/Set**.

- 3 Enter the registered four-digit password.

Press **Menu/Set**.

- 4 Enter a four-digit number for the new password.

Press **Menu/Set**.

- 5 If the LCD shows *Verify*, re-enter the new password.

Press **Menu/Set**.

- 6 Press **Stop/Exit**.

Turning TX Lock on

- 1 Press **Menu/Set**, **1**, **8**, **1**.

1.TX Lock

- 2 Press **▲** or **▼** to select **Set TX Lock**.
Press **Menu/Set**.

- 3 Enter the registered four-digit password.
Press **Menu/Set**.

The machine goes offline and the LCD shows **TX Lock Mode**.

Turning TX Lock off

- 1 Press **Menu/Set**.
Enter the registered four-digit password.
- 2 Press **Menu/Set**.
TX Lock is automatically turned off.



Note

If you enter the wrong Password, the LCD shows **Wrong Password** and stays offline. The machine will stay in TX Lock Mode until the registered password is entered.

Memory Security (FAX-2920 and MFC-7225N only)

Memory Security lets you prevent unauthorized access to the machine. You will not be able to continue to schedule Delayed Faxes or Polling jobs. However, any pre-scheduled Delayed Faxes will be sent even if you turn on Memory Security, so they won't be lost.

While Memory Security is on, the following operations are available:

- Receiving faxes into memory (limited by memory capacity)
- Fax Forwarding (if Fax Forwarding was already on)
- Paging (if Paging was already on)
- Remote Retrieval (if Fax Storage was already on)

While Memory Security is on, the following operations are NOT available:

- Sending faxes
- Printing received faxes
- Receiving telephone calls
- Making telephone calls
- Copying
- PC printing (MFC-7225N only)
- Scanning (MFC-7225N only)



Note

- To print the faxes in memory, turn off Memory Security.
- *MFC-7220 and MFC-7225N only:* You must turn off PC Fax Receive before you can turn on Memory Security. (See *Turning off Remote Fax Options* on page 6-4.)

Setting up the password



Note

- If you have already set the password, you will not need to set it, again.
- If you forget the Memory Security password, please call Brother Customer Service. (See *Brother numbers* on page i.)

- 1 Press **Menu/Set**, **1**, **8**, **1**.

1.Mem Security

- 2 Enter a four-digit number for the password.

Press **Menu/Set**.

If you are entering the password for the first time, the LCD shows *Verify*.

- 3 Re-enter the password.

Press **Menu/Set**.

- 4 Press **Stop/Exit**.

Changing the Memory Security password

- 1 Press **Menu/Set**, **1**, **8**, **1**.

1.Mem Security

- 2 Press **▲** or **▼** to select *Set Password*.

Press **Menu/Set**.

- 3 Enter the registered four-digit password.

Press **Menu/Set**.

- 4 Enter a four-digit number for the new password.

Press **Menu/Set**.

- 5 If the LCD shows *Verify*, re-enter the new password.

Press **Menu/Set**.

- 6 Press **Stop/Exit**.

Turning Memory Security on

- 1 Press **Menu/Set**, **1**, **8**, **1**.

1.Mem Security

- 2 Press **▲** or **▼** to select *Set Security*. Press **Menu/Set**.

- 3 Enter the registered four-digit password. Press **Menu/Set**.

The machine goes offline and the LCD shows *Secure Mode*.



Note

If there is a power failure, the data in the memory will remain for up to 4 days.

Turning Memory Security off

- 1 Press **Menu/Set**.

Enter the registered four-digit password.

- 2 Memory Security is automatically turned off and the LCD shows the date and time.



Note

If you enter the wrong Password, the LCD shows *Wrong Password* and stays offline. The machine will stay in *Secure Mode* until the registered password is entered.

Setting Lock

Setting Lock lets you prevent unauthorized access to the machine settings.

While Setting Lock is **On**, the following operations are NOT available without password:

- Date & Time
- Station ID
- Set Quick-Dial (One-Touch Dial, Speed-Dial and Setup Groups)
- Mode Timer
- Paper Type
- Paper Size
- Volume
- Auto Daylight
- Ecology (Toner Save and Sleep Time)
- LCD Contrast
- Security (TX Lock or Memory Security and Setting Lock)

Setting up the password



Note

- If you have already set the password, you will not need to set it, again.
 - If you forget the Setting Lock password, please call Brother Customer Service. (See *Brother numbers* on page i.)
-

- 1 Press **Menu/Set**, **1**, **8**, **2**.

2.Setting Lock

- 2 Enter a four-digit number for the password.

Press **Menu/Set**.

If you are entering the password for the first time, the LCD shows *Verify*.

- 3 Re-enter the password.

Press **Menu/Set**.

- 4 Press **Stop/Exit**.

Changing the Setting Lock password

- 1 Press **Menu/Set**, **1**, **8**, **2**.

- 2 Press **▲** or **▼** to select `Set Password`.
Press **Menu/Set**.
- 3 Enter the registered four-digit password.
Press **Menu/Set**.
- 4 Enter a four-digit number for the new password.
Press **Menu/Set**.
- 5 If the LCD shows `Verify`, re-enter the new password.
Press **Menu/Set**.
- 6 Press **Stop/Exit**.

Turning Setting Lock on

- 1 Press **Menu/Set**, **1**, **8**, **2**.

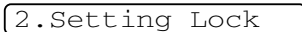
- 2 Press **▲** or **▼** to select `On`.
Press **Menu/Set**.
- 3 Enter the registered four-digit password.
Press **Menu/Set**.
- 4 Press **Stop/Exit**.

Turning Setting Lock off

- 1 Press **Menu/Set**, **1**, **8**, **2**.

- 2 Enter the registered four-digit password.
Press **Menu/Set** twice.
- 3 Press **Stop/Exit**.





Note

If you enter the wrong Password, the LCD shows `Wrong Password`. The machine will stay in `Setting Lock` mode until the registered password is entered.

3

Setup Send

How to enter Fax mode

Before sending faxes or changing fax send or receiving settings, make sure  (**Fax**) is illuminated in green. If it is not, press  (**Fax**) to enter Fax mode. The default setting is Fax mode.

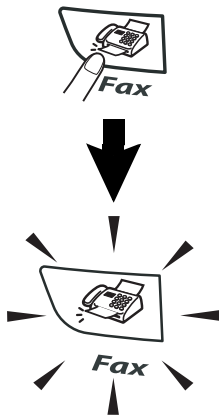

How to dial

You can dial in any of the following ways.

Manual dialing

Press all of the digits of the phone or fax number.



One-Touch Dialing

Press the One-Touch key of the location you want to call. (See *Storing One-Touch numbers* on page 5-1.)

Note

- FAX-2820 and FAX-2920 only:
To dial One-Touch numbers 11 to 20, hold down **Shift** as you press the One-Touch key.
- **Shift** is not available for MFC-7220 and MFC-7225N.

FAX-2820 and FAX-2920

MFC-7220 and MFC-7225N

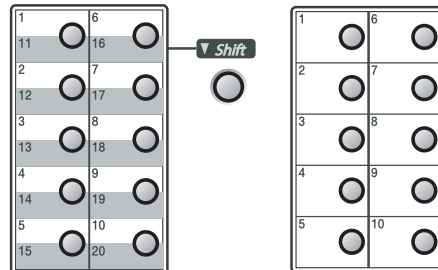

Speed-Dialing

Press **Search/Speed Dial**, #, and then the three digit Speed-Dial number. (See *Storing Speed-Dial numbers* on page 5-2.)

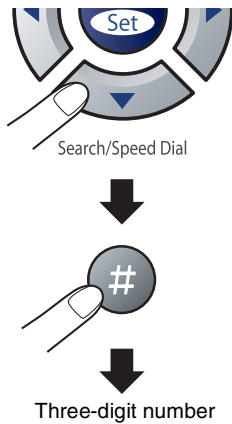

Note

If the LCD shows **Not Registered** when you enter the One-Touch or Speed-Dial number, a number has not been stored at this location.

Search

You can search for names you have stored in the One-Touch and Speed-Dial memories. Press **Search/Speed Dial** and the navigation keys to search. (See *Storing One-Touch numbers* on page 5-1 and *Storing Speed-Dial numbers* on page 5-2.)

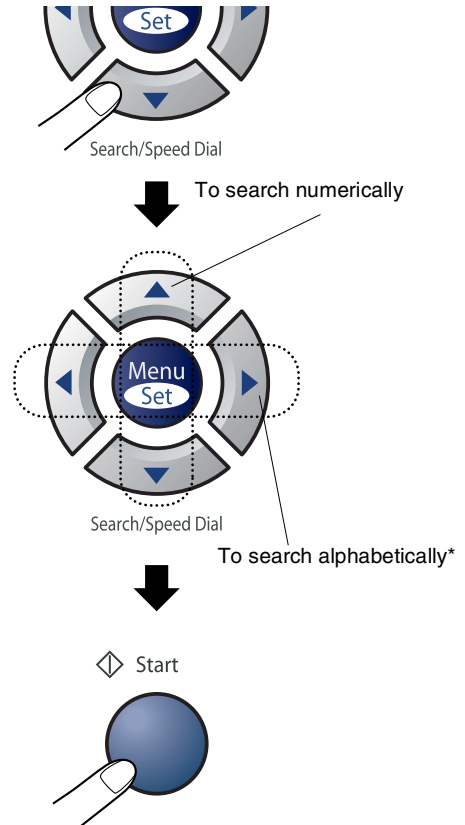

* To search alphabetically, you can use the dial pad to enter the first letter of the name you are looking for.

Fax Redial

If you are sending a fax manually and the line is busy, press **Redial/Pause**, and then press **Start** to try again. If you want to make a second call to the last number dialed, you can save time by pressing **Redial/Pause** and **Start**.

Redial/Pause only works if you dialed from the control panel.

If you are sending a fax automatically and the line is busy, the machine will automatically redial one time after five minutes.

How to Fax

Faxing from the ADF

- 1 If it is not illuminated in green, press  (**Fax**).
- 2 Put the document face down in the ADF.
- 3 Dial the fax number.
Press **Start**. The machine starts scanning the document.

Automatic transmission

This is the easiest way to send a fax.

Do **not** pick up the handset or press **Hook/Hold**.

Press **Start** immediately after dialing. (For an example of automatic faxing, follow the steps in *Faxing from the ADF* on this page.)

Manual transmission

Manual transmission lets you hear the dialing, ringing and fax-receiving tones while sending a fax.

- 1 If it is not illuminated in green, press  (**Fax**).
- 2 Load your document.
- 3 Pick up the handset and listen for a dial tone.
- 4 Dial the fax number you want to call.
- 5 When you hear the fax tone, press **Start**.
- 6 Replace the handset.

Sending a fax at the end of a conversation

At the end of a conversation you can send a fax to the other party before you both hang up.

- 1 Ask the other party to wait for fax tones (beeps) and then to press the Start or Send key before hanging up.
- 2 If it is not illuminated in green, press  (Fax).
- 3 Load your document.
Press **Start**.
- 4 Replace the handset.

Out of Memory message

If you get an **Out of Memory** message while scanning the first page of a fax, press **Stop/Exit** to cancel the fax.

If you get an **Out of Memory** message while scanning a subsequent page, you will have the option to press **Start** to send the pages scanned so far, or to press **Stop/Exit** to cancel the operation.

Note

If you get an **Out of Memory** message while faxing and you do not want to delete your stored faxes to clear the memory, you can send the fax in real time. (See *Real Time Transmission* on page 3-6.)

Basic sending operations

Sending faxes using multiple settings

When you send a fax you can choose any combination of these settings: cover page, contrast, resolution, overseas mode, delayed fax timer, polling transmission or real time transmission.

- 1 If it is not illuminated in green, press



After each setting is accepted, the LCD will ask if you want to enter more settings:

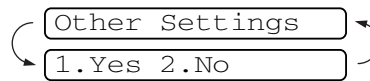

- 2 Press **1** to select more settings. The LCD will return to the **Setup Send** menu.

—OR—

Press **2** if you have finished choosing settings and go to the next step.

Contrast

If your document is very light or very dark, you may want to change the contrast.

Use **Light** to send a light document.

Use **Dark** to send a dark document.

- 1 If it is not illuminated in green, press



- 2 Load your document.

- 3 Press **Menu/Set**, **2**, **2**, **1**.

1. Contrast

- 4 Press **▲** or **▼** to select **Auto**, **Light** or **Dark**.

Press **Menu/Set**.

Fax Resolution

After you load the document, you can use the **Resolution** key to change the setting temporarily (for this fax only). In Fax mode



, press **Resolution** and **▲** or **▼** to select the setting you want, and then press **Menu/Set**.

—OR—

You can change the default setting:

- 1 If it is not illuminated in green, press



- 2 Press **Menu/Set**, **2**, **2**, **2**.

2. Fax Resolution

- 3 Press **▲** or **▼** to select the resolution you want.

Press **Menu/Set**.

Standard	Suitable for most typed documents.
Fine	Good for small print and transmits a little slower than Standard resolution.
S.Fine	Good for small print or artwork and transmits slower than Fine resolution.
Photo	Use when the document has varying shades of gray or is a photograph. This has the slowest transmission time.

Dual Access

You can dial a number, and begin scanning the fax into memory—even when the machine is sending from memory, receiving faxes or printing PC data. The LCD shows the new job number.



Note

- The number of pages you can scan into the memory will vary depending on the data that is printed on them.
- If you get an `Out of Memory` message while scanning the first page of a fax, press **Stop/Exit** to cancel scanning. If you get an `Out of Memory` message while scanning a subsequent page, you can press **Start** to send the pages scanned so far, or press **Stop/Exit** to cancel the operation.

Real Time Transmission

When you are sending a fax, the machine will scan the documents into the memory before sending. Then, as soon as the phone line is free, the machine will start dialing and sending.

If the memory is full, the machine will send the document in real time (even if `Real Time TX` is set to `Off`).

Sometimes, you may want to send an important document immediately, without waiting for memory transmission. You can set `Real Time TX` to `On` for all documents or `Next Fax:On` or `Next Fax:Off` for the next fax only.

- 1 If it is not illuminated in green, press



(Fax).

- 2 Press **Menu/Set**, **2**, **2**, **5**.

5.Real Time TX

- 3 To change the setting, press **▲** or **▼** to select `On`, `Next Fax:On`, `Next Fax:Off` or `Off`.

Press **Menu/Set**.

Broadcasting

Broadcasting is when the same fax message is automatically sent to more than one fax number. You can include Groups, One-Touch, Speed-Dial numbers and up to 50 manually dialed numbers in the same broadcast.

Press **Menu/Set** between each of the numbers. Use **Search/Speed Dial** to help you choose the numbers easily. (To set up Group dial numbers, see *Setting up Groups for Broadcasting* on page 5-3.)

After the broadcast is finished, a Broadcast Report will be printed to let you know the results.

- 1 If it is not illuminated in green, press  (**Fax**).
- 2 Load your document.
- 3 Enter a number using One-Touch, Speed-Dial, a Group number, Search or manual dialing using the dial pad.

Press **Menu/Set**.

- 4 After you have entered all the fax numbers, press **Start**.



Note

- If you did not use up any of the numbers for Groups, access codes or credit card numbers, you can 'broadcast' faxes to as many as 260 (MFC-7220 and MFC-7225N) or 270 (FAX-2820 and FAX-2920) different numbers.
 - The available memory will vary depending on the types of jobs in the memory and the number of locations used for broadcasting. If you broadcast to the maximum numbers available, you will not be able to use Dual Access and Delayed fax.
 - Enter the long dialing sequence numbers as you would normally, but remember that each One-Touch and Speed-Dial number counts as one number, so the number of locations you can store becomes limited. (See *Access codes and credit card numbers* on page 5-4.)
 - If the memory is full, press **Stop/Exit** to stop the job or if more than one page has been scanned, press **Start** to send the portion that is in the memory.
-

Checking job status

Check which jobs are still waiting in the memory to be sent. (If there are no jobs, the LCD shows `No Jobs Waiting`.)

- 1 Press **Menu/Set**, **2**, **6**.

`6.Remaining Jobs`

- 2 If you have more than one job waiting, press **▲** or **▼** to scroll through the list.
- 3 Press **Stop/Exit**.

Canceling a fax in progress

If you want to cancel a fax, while the machine is scanning, dialing or sending it, press **Stop/Exit**.

Canceling a scheduled job

You can cancel a fax job that is stored and waiting in the memory.

- 1 Press **Menu/Set**, **2**, **6**.

`6.Remaining Jobs`

Any jobs that are waiting will appear on the LCD.

- 2 If you have more than one job waiting, press **▲** or **▼** to select the job you want to cancel.

Press **Menu/Set**.

—OR—

If you only have one job waiting, go to Step 3.

- 3 Press **1** to cancel.

To cancel another job go to Step 2.

—OR—

Press **2** to exit without canceling.

- 4 Press **Stop/Exit**.

Advanced sending operations

Composing the electronic Cover Page

The Cover Page is sent to the receiving party's machine. Your Cover Page includes the name stored in the One-Touch or Speed-Dial memory. If you are dialing manually, the name is left blank.

The Cover Page shows your Station ID and the number of pages you're sending. (See *Setting the Station ID* on page 2-2.) If you have Cover Page set to **On** for all faxes (**Menu/Set, 2, 2, 7**), the number of pages is not shown on the cover page.

You can select a comment to include on your Cover Page.

1. Comment Off
2. Please Call
3. Urgent
4. Confidential

Instead of using one of the preset comments, you can enter two personal messages of your own, up to 27 characters long. Use the chart on B-11 for help entering characters. (See *Composing your own comments* on page 3-9.)

5. (User Defined)
6. (User Defined)

Most of the **Setup Send** settings are temporary to allow you to make changes for each fax you send. However, when you set up your Cover Page and Cover Page Comments, you are changing the default settings so they will be available while faxing.

Composing your own comments

You can set up two comments of your own.

- 1 If it is not illuminated in green, press  (**Fax**).
- 2 Press **Menu, 2, 2, 8**.

8. Coverpage Msg
- 3 Press **▲** or **▼** to choose 5 or 6 for your own comment.
Press **Menu/Set**.
- 4 Use the dial pad to enter your customized comment.
Press **Menu/Set**.
(See *Entering Text* on page B-11.)

Cover page for the next fax only

If you have not yet set your Station ID this feature will not work. Make sure you have programmed the Station ID before continuing. (See *Setting the Station ID* on page 2-2.) If you only want to send a Cover Page with a particular fax, your machine will ask you to enter the number of pages you are sending so it can be printed on the Cover Page.

- 1 If it is not illuminated in green, press  (**Fax**).
- 2 Load your document.
- 3 Press **Menu, 2, 2, 7**.



7. Coverpg Setup
- 4 Press **▲** or **▼** to select **Next Fax:On** (or **Next Fax:Off**).
Press **Menu/Set**.

- 5 Press ▲ or ▼ to select one of the standard or your own comments.
Press **Menu/Set**.
- 6 Enter two digits to show the number of pages you are sending.
Press **Menu/Set**.
(For example, press **0, 2** for 2 pages or enter **00** to leave the number of pages blank. If you make a mistake, press ◀ to back up and re-enter the number of pages.)

Send a cover page for all faxes

If you have not yet set your Station ID this feature will not work. Make sure you have programmed the Station ID before continuing. (See *Setting the Station ID* on page 2-2.)

You can set the machine to send a cover page whenever you send a fax. The number of pages in your fax is not included when you use this setting.

- 1 If it is not illuminated in green, press  (**Fax**).
- 2 Press **Menu/Set, 2, 2, 7**.

- 3 Press ▲ or ▼ to select to select **On** (or **Off**).
Press **Menu/Set**.
- 4 If you selected **On**, press ▲ or ▼ to select one of the standard or your own comments.
Press **Menu/Set**.

Using a printed cover page

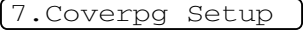
If you prefer to use a printed cover page that you can write on, you can print the sample page and attach it to your fax.

- 1 If it is not illuminated in green, press  (**Fax**).
- 2 Press **Menu/Set, 2, 2, 7**.

- 3 Press ▲ or ▼ to select **Print Sample**.
Press **Menu/Set**.
- 4 Press **Start**. Your machine prints a copy of your cover page.

Overseas Mode

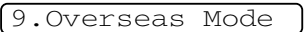
If you are having difficulty sending a fax overseas due to possible interference on the phone line, we recommend that you turn on the Overseas Mode. After you send a fax using this feature, the feature will turn itself off.

- 1 If it is not illuminated in green, press  (**Fax**).
- 2 Load your document.
- 3 Press **Menu/Set, 2, 2, 9**.

- 4 Press ▲ or ▼ to select **On** (or **Off**).
Press **Menu/Set**.

Delayed Fax

During the day you can store up to 50 faxes in the memory to be sent within 24 hours. These faxes will be sent at the time of day you enter in Step 4.

- 1 If it is not illuminated in green, press



(Fax).

- 2 Load your document.

- 3 Press **Menu/Set, 2, 2, 3.**

3.Delayed Fax

- 4 Press **Menu/Set** to accept the displayed time.

—OR—

Enter the time you want the fax to be sent (in 24-hour format).

(For example, enter 19:45 for 7:45 PM.)

Press **Menu/Set**.

1.Doc 2.Memory

- 5 Press **1** to leave the paper document waiting in the ADF.

—OR—

Press **2** to scan the document into the memory.



Note

The number of pages you can scan into the memory depends on the amount of data that is printed on each page.

Delayed Batch Transmission

Before sending the delayed faxes, your machine will help you economize by sorting all the faxes in the memory by destination and scheduled time. All delayed faxes that are scheduled to be sent at the same time to the same fax number will be sent as one fax to save transmission time.

- 1 If it is not illuminated in green, press



(Fax).

- 2 Press **Menu/Set, 2, 2, 4.**

4.Batch TX

- 3 Press **▲** or **▼** to select **On** (or **Off**).

Press **Menu/Set**.

- 4 Press **Stop/Exit**.

Setting up Polled Transmit

Polled Transmit is when you set up your machine to wait with a document so another fax machine can call and retrieve it. Everyone who is involved in Polling needs to set up their machines for Polling.



Note

- When someone polls your machine to receive a fax, they pay for the call.
- If you poll someone's fax machine to receive a fax, you pay for the call.



Note

- If you press **1** in Step **5**, the document remains in the ADF until your machine is polled. If you must use your machine before the polled transmission occurs, you must first cancel this job.
- If you press **2** in Step **5**, the document will be stored and can be retrieved from any other fax machine until you delete the fax in memory by using the Canceling a Job menu setting. (See *Canceling a scheduled job* on page 3-8.)

- 1 If it is not illuminated in green, press



(Fax).

- 2 Load your document.

- 3 Press **Menu/Set**, **2**, **2**, **6**.

6.Polled TX

- 4 Press **▲** or **▼** to select **On** (or **Off**).

Press **Menu/Set**.

1.Doc 2.Memory

- 5 Press **1** to leave the paper document waiting in the ADF.

—OR—

Press **2** to scan the document into the memory.

4

Setup Receive

Basic receiving operations

Choosing the Receive Mode

There are four different Receive Modes for your machine. You can choose the mode that best suits your needs.

LCD	How it works	When to use it
Fax Only (automatic receive)	The machine automatically answers every call as a fax.	For dedicated fax lines.
Fax/Tel (fax and telephone)	The machine controls the line and automatically answers every call. If the call is a fax it will receive the fax. If the call is not a fax it will ring (pseudo/double ring) for you to pick up the call.	Use this mode if you expect to receive lots of fax messages and few telephone calls. You cannot have an answering machine on the same line, even if it is on a separate wall jack on the same line. You cannot use the telephone company's Voice Mail in this mode.
External TAD (with an external telephone answering device only)	The external telephone answering machine device (TAD) automatically answers every call. Voice messages are stored on the external TAD. If it is a fax call, the machine receives the Fax.	Use this mode if you have connected an answering machine to your machine. The External TAD setting works only with an external answering machine. Ring Delay does not work in this setting.
Manual (manual receive) (with Distinctive Ring)	You control the phone line and must answer every call yourself unless you are using the Distinctive Ring feature.	Use this mode if you do not receive many fax messages, use Distinctive Ring, or if you are using a computer on the same line. If you answer and hear fax tones, wait until the machine takes over the call, then hang up. (See <i>Easy Receive</i> on page 4-3.)

To select or change your Receive Mode

- 1 Press **Menu/Set**, **0**, **1**.
- 2 Press **▲** or **▼** to select **Fax Only**, **Fax/Tel**, **External TAD** or **Manual**.
 Press **Menu/Set**.
- 3 Press **Stop/Exit**.

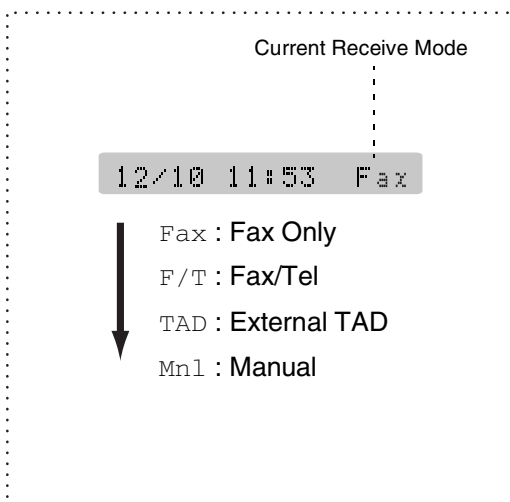

Setting the Ring Delay

The Ring Delay sets the number of times the machine rings before it answers in **Fax Only** or **Fax/Tel** mode. If you have extension phones on the same line as the machine or subscribe to the telephone company's Distinctive Ring service, keep the Ring Delay setting of 4.

(See *Operation from extension telephones* on page A-4 and *Easy Receive* on page 4-3.)

- 1 If it is not illuminated in green, press  (**Fax**).
- 2 Press **Menu/Set**, **2**, **1**, **1**.
- 3 Press **▲** or **▼** to select how many times the line rings before the machine answers (00 - 04).
 Press **Menu/Set**.
 (If you select 00, the line won't ring at all.)
- 4 Press **Stop/Exit**.

Setting the F/T Ring Time (Fax/Tel mode only)

If you set the Receive Mode to `Fax/Tel`, you'll need to decide how long the machine will signal you with its special pseudo/double-ring when you have a voice call. (If it's a fax call, the machine receives the fax.)

This pseudo/double-ring happens after the initial ringing from the phone company. Only the machine rings and no other phones on the same line will ring with the special pseudo/double-ring. However, you can still answer the call on any telephone on the same line as the machine. (See *For Fax/Tel mode only* on page A-4.)

- 1 If it is not illuminated in green, press



(Fax).

- 2 Press **Menu/Set**, **2**, **1**, **2**.

2.F/T Ring Time

- 3 Press **▲** or **▼** to select how long the machine will ring to alert you that you have a voice call (20, 30, 40 or 70 seconds).

Press **Menu/Set**.

- 4 Press **Stop/Exit**.



Note

Even if the caller hangs up during the pseudo/double-ringing, the machine will continue to ring for the set time.

Easy Receive

When you use this feature you don't have to press **Start** or the Fax Receive Code *** 5 1** when you answer a fax call and hear calling beeps. Just hold the handset and wait a few seconds. Selecting `On` allows the machine to receive fax calls automatically, even if you lift the machine's handset or the handset of an extension or external phone. When you see `Receiving` on the LCD or when you hear "chirps" through the handset of an extension phone connected to another wall jack, just replace the handset and your machine will do the rest. `Semi` lets the machine receive the fax only if you've answered it at the machine.



Note

- If you've set the feature to `On`, but your machine does not automatically connect a fax call when you lift an external or extension phone handset, press the Fax Receive code *** 5 1**. At the machine, lift the handset and then press **Start**.
- If you send faxes from a computer on the same phone line and the machine intercepts them, set Easy Receive to `Off`.
- Selecting `Off` means you'll have to activate the machine yourself by pressing **Start** on the machine.
—OR—
by pressing *** 5 1** if you are not at your machine. (See *Operation from extension telephones* on page A-4.)

- 1 If it is not illuminated in green, press



(Fax).

- 2 Press **Menu/Set**, **2**, **1**, **3**.

3.Easy Receive

- 3 Press **▲** or **▼** to select `On`, `Semi` or `Off`.
Press **Menu/Set**.

- 4 Press **Stop/Exit**.

Printing a reduced incoming fax (Auto Reduction)

If you choose **On**, the machine automatically reduces an incoming fax to fit on one page of Letter, Legal or A4 size paper. The machine calculates the reduction ratio by using the page size of the document and your Paper Size setting (**Menu/Set, 1, 3**).

- 1 If it is not illuminated in green, press



- 2 Press **Menu/Set, 2, 1, 5**.

5.Auto Reduction

- 3 Use ▲ or ▼ to select **On** (or **Off**).

Press **Menu/Set**.

- 4 Press **Stop/Exit**.



Note

- Turn on this setting if you receive faxes that are split onto two pages. However, if the document is too long the machine may still print on two pages.
- If left and right margins are cut off, turn on this setting.
- When this feature is set to **On**, the Letter, Legal or A4 faxes people send to you may appear slightly shrunk even though your machine prints them on Letter, Legal or A4 paper. This is because the machine has to print the Station ID of the sending machine at the top of the page.

Receiving a fax at the end of a conversation

At the end of a conversation you can ask the other party to fax you information before you both hang up.

- 1 Ask the other party to place the document in their machine and to press **Start** or **Send** key.
- 2 When you hear the other machine's CNG tones (beeps), press **Start**.
- 3 Replace the handset.

Advanced receiving operations

Printing a fax from the memory

If you have selected Fax Storage (**Menu/Set, 2, 5, 1**), you can still print a fax from the memory when you are at your machine. (See *Setting Fax Storage* on page 6-2.)

- 1 Press **Menu/Set, 2, 5, 3**.

3.Print Fax

- 2 Press **Start**.

Setting the Print Density

You can adjust print density, making your printed pages darker or lighter.

- 1 If it is not illuminated in green, press



- 2 Press **Menu/Set, 2, 1, 6**.

6.Print Density

- 3 Press **▲** to make the print darker.

—OR—

Press **▼** to make the print lighter.

Press **Menu/Set**.

- 4 Press **Stop/Exit**.

Polling

Polling is the process of retrieving faxes from another fax machine.

Everyone who is involved in Polling needs to set up their machines for Polling.



Note

- If you poll someone's fax machine to receive a fax, you pay for the call.
- Some fax machines do not respond to the Polling feature.

Setting up Polling Receive

Polling Receive is when you call another fax machine to receive a fax from it.

- 1 If it is not illuminated in green, press



- 2 Press **Menu/Set, 2, 1, 7**.

7.Polling RX

- 3 Enter the fax number you are polling.

- 4 Press **Start**.

The LCD shows *Dialing*.

Setting up Sequential Polling Receive

Your machine can ask for faxes from several fax units in a single operation (Sequential Polling Receive). Afterwards, a Sequential Polling Report will be printed.

- 1 If it is not illuminated in green, press



(Fax).

- 2 Press **Menu/Set**, **2**, **1**, **7**.

7.Polling RX

- 3 Enter the fax machines you want to poll using One-Touch, Speed-Dial, a Group or the dial pad. You must press **Menu/Set** between each fax number.

- 4 Press **Start**. Your machine will poll each number or Group number in turn to receive a fax.

The LCD shows *Dialing*.

5

Quick-Dial numbers and dialing options

Storing numbers for easy dialing

You can set up your machine to do following types of easy dialing: One-Touch, Speed-Dial and Groups for Broadcasting faxes. When you dial a quick-dial number, the LCD shows the name, if you stored it, or the number.



Note

If you lose electrical power, the quick-dial numbers that are in the memory will not be lost.

Storing One-Touch numbers

Your machine has 10 One-Touch keys where you can store 10 (MFC-7220 and MFC-7225N) or 20 (FAX-2820 and FAX-2920) fax or phone numbers for automatic dialing. To access numbers 11 to 20 (FAX-2820 and FAX-2920), hold down **Shift** as you press the One-Touch key. The LCD shows the name, if you stored it, or the number.



Note

Shift is not available for MFC-7220 and MFC-7225N.

FAX-2820 and
FAX-2920

MFC-7220 and
MFC-7225N

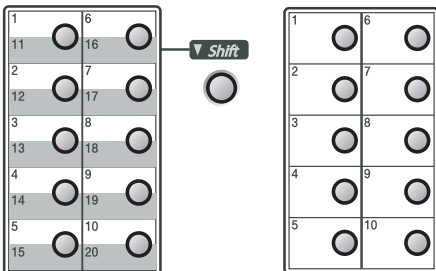

- 1 Press **Menu/Set**, **2**, **3**, **1**.

1.One-Touch Dial

- 2 Press the One-Touch key where you want to store a number.

- 3 Enter the phone or fax number (up to 20 digits).

Press **Menu/Set**.

- 4 Use the dial pad to enter the name (up to 15 characters).

Press **Menu/Set**.

(You can use the chart on page B-11 to help you enter letters.)

—OR—

Press **Menu/Set** to store the number without a name.

- 5 Go to Step 2 to store another One-Touch number.

—OR—

Press **Stop/Exit**.

Storing Speed-Dial numbers

You can store Speed-Dial numbers, so that when you dial you will only have to press a few keys (**Search/Speed Dial**, **#**, the three-digit number, and **Start**). The machine can store 200 Speed-Dial numbers.

- 1 Press **Menu/Set**, **2**, **3**, **2**.

2.Speed-Dial

- 2 Use the dial pad to enter a three-digit Speed-Dial location number (001 - 200). (For example, press **005**.)

Press **Menu/Set**.

- 3 Enter the phone or fax number (up to 20 digits).

Press **Menu/Set**.

- 4 Use the dial pad to enter the name (up to 15 characters).

Press **Menu/Set**.

(You can use the chart on page B-11 to help you enter letters.)

—OR—

Press **Menu/Set** to store the number without a name.

- 5 Go to Step 2 to store another Speed-Dial number.

—OR—

Press **Stop/Exit**.

Changing One-Touch / Speed-Dial numbers

If you try to store a One-Touch or Speed-Dial number where a number has already been stored, the LCD will show the name that has been stored there (or number) and will ask you to do one of the following:



- 1 Press **1** to change the stored number.

—OR—

Press **2** to exit without making a change.

How to change the stored number or name:

- If you want to change a character, use ◀ or ▶ to position the cursor under the character you want to change, and then type over it.
- If you want to erase the whole number or whole name, press **Stop/Exit** when the cursor is under the first digit or letter. The characters above and to the right of the cursor will be deleted.

- 2 Enter a new number.

Press **Menu/Set**.

- 3 Follow the directions beginning at Step 4 in Storing One-Touch Dial numbers and Storing Speed-Dial numbers. (See *Storing One-Touch numbers* on page 5-1 and *Storing Speed-Dial numbers* on page 5-2.)

Setting up Groups for Broadcasting

Groups, which can be stored on a One-Touch key or a Speed-Dial location, allow you to send the same fax message to many fax numbers by pressing only a One-Touch key and **Start** or **Search/Speed Dial**, #, the three-digit location and **Start**. First, you'll need to store each fax number as a One-Touch or Speed-Dial number. Then, you can combine them into a Group. Each Group uses up a One-Touch key or a Speed-Dial location. You can have up to eight Groups, or you can assign up to 219 (FAX-2820 and FAX-2920) and 209 (MFC-7220 and MFC-7225N) numbers to one large Group. (See *Storing One-Touch numbers* on page 5-1 and *Storing Speed-Dial numbers* on page 5-2.)

- 1 Press **Menu/Set**, **2**, **3**, **3**.

3.Setup Groups

- 2 Decide where you wish to store the Group.

—AND—

Press a One-Touch key.

—OR—

Press **Search/Speed Dial** and enter the three digit location, and then press **Menu/Set**.

(For example, press One-Touch key **1** for Group 1.)

- 3 Use the dial pad to enter the Group number (1 to 8).

Setup Group:G01

Press **Menu/Set**.

(For example, press **1** for Group 1.)



Note

The Group number must be between 1 and 8.

- 4 To include One-Touch or Speed-Dial numbers in the Group, press them as follows:

For example, for One-Touch number 2, press One-Touch key **2**. The LCD shows *** 002**. For Speed-Dial location 009, press **Search/Speed Dial**, and then **009** on the dial pad.

G01: * 002#009

- 5 Press **Menu/Set** to accept the numbers for this Group.
- 6 Use the dial pad and the chart on page B-11 to enter a name for the Group.

Press **Menu/Set**.

(For example, type **NEW CLIENTS**).

- 7 Press **Stop/Exit**.



Note

You can print a list of all One-Touch and Speed-Dial numbers. Group numbers will be marked in the **GROUP** column. (See *Printing reports* on page 7-2.)

Dialing options

Access codes and credit card numbers

Sometimes you may want to choose from several long distance carriers when you make a call. Rates may vary depending on the time and destination. To take advantage of low rates, you can store the access codes or long-distance carriers and credit card numbers as One-Touch and Speed-Dial numbers. You can store these long dialing sequences by dividing them and setting them up on separate One-Touch and Speed Dial numbers in any combination. You can even include manual dialing using the dial pad. (See *Storing One-Touch numbers* on page 5-1 and *Storing Speed-Dial numbers* on page 5-2.)

For example, perhaps you have stored '555' on One-Touch key **1** and '7000' on One-Touch key **2**. If you press One-Touch key **1**, One-Touch key **2**, and **Start**, you will dial '555-7000'.

To temporarily change a number, you can substitute part of the number with manual dialing using the dial pad.

For example, to change the number to 555-7001 you could press One-Touch key **1** and then press **7001** using the dial pad.

Pause

Press **Redial/Pause** to insert a 3.5-second pause between numbers. If you are dialing overseas, you can press **Redial/Pause** as many times as needed to increase the length of the pause.

Tone or Pulse (For Canada only)

If you have a Pulse dialing service, but need to send Tone signals (for example, for telephone banking), follow the instructions below. If you have Touch Tone service, you will not need this feature to send tone signals.

- 1 Lift the handset.
- 2 Press **#**. Any digits dialed after this will send tone signals.

When you hang up, the machine will return to the Pulse dialing service.

6

Remote Fax Options

Setting Remote Fax Options



Note

- You can only use one remote fax option at a time:
Fax Forwarding—OR—Paging—OR—Fax Storage—OR—PC FAX Receive*—OR—Off.
*MFC-7220 and MFC-7225N only
- If received faxes are still in the machine's memory when you change the remote fax options, an LCD question will appear. (See *Changing Remote Fax Options (MFC-7220 and MFC-7225N only)* on page 6-4.)

Setting up Fax Forwarding

When you select Fax Forward, your machine stores the received fax in the memory. The machine will then dial the fax number you've programmed and forward the fax message.

1

Press **Menu/Set**, **2**, **5**, **1**.

1. Fwd/ Page/ Store

2

Press **▲** or **▼** to select **Fax Forward**.

Press **Menu/Set**.

The LCD will ask you to enter the fax number to which faxes will be forwarded.

3

Enter the forwarding number (up to 20 digits).

Press **Menu/Set**.

4

Press **▲** or **▼** to select
Backup Print:On or
Backup Print:Off.

Backup Print:On

Press **Menu/Set**.



Note

If you select **Backup Print:On**, the machine will also print the fax at your machine so you will have a copy. This is a safety feature in case there is a power failure before the fax is forwarded or a problem at the receiving machine. The FAX-2920 and MFC-7225N can store faxes up to 4 days if there is a power failure. The faxes stored in the FAX-2820 and MFC-7220 memory will be deleted.

5

Press **Stop/Exit**.

Programming your pager number

When Paging is selected, your machine dials the pager number you've programmed, and then dials your Personal Identification Number (PIN). This activates your pager so you will know that you have a fax message in the memory.

- 1 Press **Menu/Set**, **2**, **5**, **1**.

1.Fwd/Page/Store

- 2 Press **▲** or **▼** to select **Paging**.
Press **Menu/Set**.

- 3 Enter your pager phone number followed by # # (up to 20 digits).

Press **Menu/Set**.

Do not include the area code if it is the same as that of your machine.

For example, press:

1 8 0 0 5 5 1 2 3 4 # #

- 4 If your pager needs a PIN, enter the PIN, press #, press **Redial/Pause**, enter your fax number followed by # #.

Press **Menu/Set**.

For example, press:

1 2 3 4 5 # Redial/Pause 1 8 0 0 5 5 1 2 1 2 # #

—OR—

If you do not need a PIN, press **Redial/Pause**, enter your fax number followed by # #.

Press **Menu/Set**.

For example, press:

Redial/Pause 1 8 0 0 5 5 1 2 1 2 # #

- 5 Press **Stop/Exit**.



Note

- You cannot change a Paging number or PIN remotely.
- If you have set Paging, a backup copy of the received fax will automatically be printed at the machine.

Setting Fax Storage

If you select Fax Storage, your machine stores the received fax in the memory. You will be able to retrieve fax messages from another location using the Remote Retrieval commands.

- 1 Press **Menu/Set**, **2**, **5**, **1**.

1.Fwd/Page/Store

- 2 Press **▲** or **▼** to select **Fax Storage**.
Press **Menu/Set**.

- 3 Press **Stop/Exit**.



Note

If you have set Fax Storage, a backup copy will automatically be printed at the machine.

PC Fax Receive (MFC-7220 and MFC-7225N only)

If you turn on the PC Fax Receive feature your machine will store your received fax in memory and send them to your PC automatically. You can then use your PC to view and store these faxes.

Even if you have turned off your PC (at night or on the weekend, for example), your machine will receive and store your faxes in its memory. The LCD will show the number of stored faxes received, for example:

```
PC Fax Msg:001
```

When you start your PC and the PC Fax Receiving software runs, your machine transfers your faxed to your PC automatically.

To transfer the received faxes to your PC you must have the PC Fax Receiving software running on your PC. (For details, see *Running PC-FAX Receiving* in the Software User's Guide on the CD-ROM.)

If you select `Backup Print:On` the machine will also print the fax

- 1 Press **Menu/Set**, **2**, **5**, **1**.

```
1.Fwd/Page/Store
```

- 2 Press **▲** or **▼** to select `PC Fax Receive`.

Press **Menu/Set**.

- 3 Press **▲** or **▼** to select `Backup Print:On` or `Backup Print:Off`.

```
Backup Print:On
```

Press **Menu/Set**.

- 4 Press **Stop/Exit**.



Note

- When Backup Print is *off*, your fax messages are automatically erased from your machine's memory when they have been successfully sent your PC. When Backup Print is *on*, your fax messages are erased when they have been successfully printed and sent to the PC.
- In the event of a power failure, the MFC-7225N will store your faxes in memory for up to 4 days. However, if you select `Backup Print:On`, the machine will print each fax, so you will have a copy if there is a power failure before it is sent to the PC.
- If you get an error message and the machine cannot print the faxes in memory, you can use this setting to transfer your faxes to your PC. (For details, see *Error messages* on page 11-1.)
- You cannot turn on PC Fax Receive if Memory Security is on.

Turning off Remote Fax Options

- 1 Press **Menu/Set**, **2**, **5**, **1**.

1.Fwd/Page/Store

- 2 Press **▲** or **▼** to select **Off**.
Press **Menu/Set**.

- 3 Press **Stop/Exit**.



Note

If you set the remote fax options to Off and received faxes are left in your machine's memory, follow the LCD messages that appear after Step 3. (See *Changing Remote Fax Options (MFC-7220 and MFC-7225N only)*.)

Changing Remote Fax Options (MFC-7220 and MFC-7225N only)

If received faxes are left in your machine's memory when you change *from* the remote fax options the LCD will ask you the following question.

Erase All Fax?
1.Yes 2.No

—OR—

Print All Fax?
1.Yes 2.No

- If you press **1**, faxes in the memory will be erased or printed before the setting changes.
- If you press **2**, faxes in the memory will not be erased and the setting will be unchanged.

(For MFC-7220 and MFC-7225N)

If received faxes are left in the machine's memory when you change *to* PC Fax Receive from another remote fax option (Fax Forward or Fax Storage), the LCD will ask you the following message:

Send Fax to PC?
1.Yes 2.No

- If you press **1**, faxes in the memory will be sent to your PC before the setting changes.
- If you press **2**, faxes in the memory will not be erased and the setting will be unchanged.

Setting your Remote Access Code

The remote access code lets you access the Remote Retrieval features when you are away from your machine. Before you use the remote access and retrieval features, you have to set up your own code. The default code is inactive code (--- *).

- 1 Press **Menu/Set**, **2**, **5**, **2**.

2. Remote Access

- 2 Enter a three-digit code using numbers **0-9**, ***** or **#**.

Press **Menu/Set**. (The preset ‘ * ’ cannot be changed.)



Note

Do not use the same code as your Fax Receive Code (***51**) or Telephone Answer Code (**#51**).
(See *Operation from extension telephones* on page A-4.)

- 3 Press **Stop/Exit**.



Note

You can change your code at any time by entering a new one. If you want to make your code inactive, press **Stop/Exit** in Step 2 to restore the inactive setting (--- *) and press **Menu/Set**.

Remote Retrieval

You can call your machine from any touch tone telephone or fax machine, then use the Remote Access Code and remote commands to retrieve fax messages. Be sure to cut out the Remote Retrieval Access Card on the last page and keep it with you at all times.

Using your Remote Access Code

- 1 Dial your fax number from a telephone or another fax machine using touch tone.
- 2 When your machine answers, immediately enter your Remote Access Code (3 digits followed by *).
- 3 The machine signals if it has received fax messages:
 - 1 long beep — Fax messages**
 - No beeps — No messages**
- 4 The machine gives two short beeps to tell you to enter a command. The machine will hang up if you wait longer than 30 seconds to enter a command. The machine will beep three times, if you enter an invalid command.
- 5 Press **9 0** to reset the machine when you've finished.
- 6 Hang up.



Note

If your machine is set to **Manual** mode and you want to use the remote retrieval features, you can access your machine by waiting about 2 minutes after it starts ringing, and then entering the Remote Access Code within 30 seconds.

Remote commands

Follow the commands below to access features when you are away from the machine. When you call the machine and enter your Remote Access Code (3 digits followed by *), the system will give two short beeps and you must enter a remote command.

Remote commands	Operation details
95 Change the Fax Forwarding, Paging or Fax Storage settings	
1 OFF	You can select OFF after you have retrieved or erased all your messages.
2 Fax Forwarding	If you hear one long beep, the change has been accepted. If you hear three short beeps, you cannot change it because something has not been set up (for example, perhaps a Fax Forwarding or Paging number had not been registered). You can register your Fax Forwarding number by entering 4. (See <i>Changing your Fax Forwarding number</i> on page 6-7.) Once you have registered the number, Fax Forwarding will work. You can select OFF after you have retrieved or erased all your messages.
3 Paging	
4 Fax Forwarding number	
6 Fax Storage	
96 Retrieve a fax	
2 Retrieve all faxes	Enter the number of a remote fax machine to receive stored fax message(s). (See page 6-7.)
3 Erase faxes from the memory	If you hear one long beep, fax messages have been erased from the memory.
97 Check the receiving status	
1 Fax	You can check whether your machine has received any faxes. If yes, you will hear one long beep. If no, you will hear three short beeps.
98 Change the Receive Mode	
1 External TAD	If you hear one long beep, your change has been accepted.
2 Fax/Tel	
3 Fax Only	
90 Exit	Press 90 to exit Remote Retrieval. Wait for the long beep, then replace the handset.

Retrieving fax messages

You can call your machine from any touch tone phone and have your fax messages sent to a fax machine.

- 1 Dial your fax number.
- 2 When your machine answers, immediately enter your Remote Access Code (3 digits followed by *). If you hear one long beep, you have messages.
- 3 As soon as you hear two short beeps, use the dial pad to press **9 6 2**.
- 4 Wait for the long beep, and then use the dial pad to enter the number of the remote fax machine where you want your fax messages sent to followed by ## (up to 20 digits).



Note

You cannot use * and # as dial numbers. However, press # if you want to store a pause.

- 5 Hang up after you hear your machine beep. Your machine will call the other fax machine, which will then print your fax messages.

Changing your Fax Forwarding number

You can change the default setting of your fax forwarding number from another telephone or fax machine using touch tone.

- 1 Dial your fax number.
- 2 When your machine answers, immediately enter your Remote Access Code (3 digits followed by *). If you hear one long beep, you have messages.
- 3 When you hear two short beeps, use the dial pad to press **9 5 4**.
- 4 Wait for the long beep, and then use the dial pad to enter the new number of the remote fax machine where you want your fax messages forwarded followed by ## (up to 20 digits).
- 5 Press **9 0** to reset the machine you have finished.



Note

You cannot use * and # as dial numbers. However, press # if you want to store a pause.

- 6 Hang up after you hear your machine beep.

Fax settings and activity

You need to set up the Transmission Verification Report and Journal Period in the menu table.

Press **Menu/Set, 2, 4, 1.**

1. Transmission

—OR—

Press **Menu/Set, 2, 4, 2.**

2. Journal Period

Customizing the Transmission Verification Report

You can use the Transmission Report as proof that you sent a fax. This report lists the time and date of transmission and whether the transmission was successful (OK). If you select **On** or **On+Image**, the report will print for every fax you send.

If you send a lot of faxes to the same place, you may need more than the job numbers to know which faxes you must send again.

Selecting **On+Image** or **Off+Image** will print a section of the fax's first page on the report to help you remember.



Note

When the Verification Report is turned **Off** or **Off+Image**, the Report will only print if there is a transmission error, with NG in the RESULT column.

1 Press **Menu/Set, 2, 4, 1.**

1. Transmission

2 Press **▲** or **▼** to select **On**, **On+Image**, **Off** or **Off+Image**.

Press **Menu/Set**.

3 Press **Stop/Exit**.

Setting the Journal Period

You can set the machine to print a journal at specific intervals (every 50 faxes, 6, 12 or 24 hours, 2 or 7 days). If you set the interval to **Off**, you can print the report by following the steps on Printing reports.

The default setting is **Every 50 Faxes**.

- 1 Press **Menu/Set**, **2**, **4**, **2**.

2. **Journal Period**

- 2 Press **▲** or **▼** to choose an interval.
Press **Menu/Set**.

(If you choose 7 days, the LCD will ask you to choose a day on which to begin the 7-day countdown.)

- 3 Enter the time to begin printing in 24-hour format.

Press **Menu/Set**.

(For example: enter 19:45 for 7:45 PM.)

- 4 Press **Stop/Exit**.



Note

- If you select 6, 12, 24 hours, 2 or 7 days, the machine will print the report at the selected time and then erase all jobs from its memory. If the machine's memory becomes full with 200 jobs before the time you selected has passed, the machine will print the Journal early and then erase all jobs from memory. If you want an extra report before it is due to print, you can print it without erasing the jobs from memory.
- If you select **Every 50 Faxes**, the machine will print the Journal when the machine has stored 50 jobs.

Printing reports

Following reports are available:

1. **Transmission**
Prints a Transmission Verification Report for your last transmission.
2. **Help List**
Prints the Help List so you can see at-a-glance how to quickly program your machine.
3. **Quick-Dial**
Lists names and numbers stored in the One-Touch and Speed-Dial memory, in numerical order.
4. **Fax Journal**
Lists information about the last incoming and outgoing faxes.
(TX means Transmit.) (RX means Receive.)
5. **User Settings**
Lists your settings.
6. **Network Config**
(MFC-7225N only)
Lists your Network settings.

How to print a report

- 1 Press **Reports**.
- 2 Press **▲** or **▼** to select the report you want.
Press **Menu/Set**.
—OR—
Enter the number of the report you want to print.
For example, press **2** to print the Help List.

Using the machine as a copier

You can use your machine as a copier, making up to 99 copies at a time.

Enter Copy mode

Before making copies, make sure that

 (**Copy**) is illuminated in green. If it is

not, press  (**Copy**) to enter **Copy** mode.

The default setting is Fax mode. You can change the number of seconds or minutes that the machine stays in **Copy** mode. (See *Setting the Mode Timer (FAX-2820 and FAX-2920 only)* on page 2-3.)

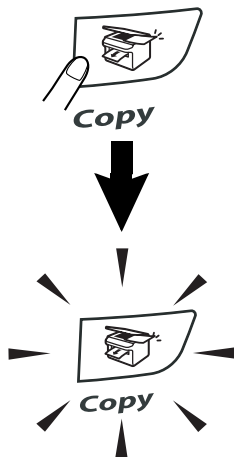

The LCD shows the default copy setting

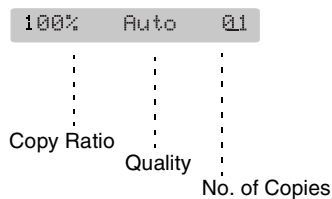

The printable area of your machine begins at approximately 0.16 in. (4 mm) from both sides and 0.12 in. (3 mm) from the top or bottom of the paper.

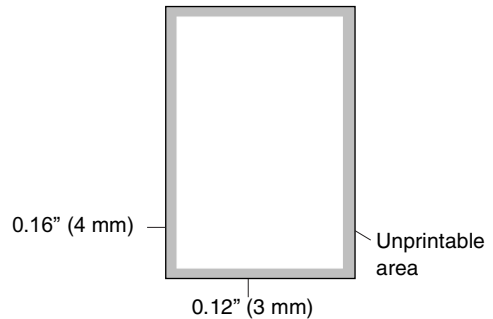

Note

This printable area shown above is for a single copy or a 1 in 1 copy using Letter or Legal size paper. The printable area changes with the paper size.

Making a single copy

- 1 Press  (**Copy**) to illuminate it in green.
- 2 Load your document. (See *Load document* on page 1-7.)
- 3 Press **Start**.

Making multiple copies

- 1 Press  (**Copy**) to illuminate it in green.
- 2 Load your document.
- 3 Use the dial pad to enter the number of copies you want (up to 99).
- 4 Press **Start**.



Note

To sort the copies, press **Options** and ▲ or ▼ to select *Stack/Sort*. (See *Sorting copies using the ADF* on page 8-5.)

Stop copying

To stop copying, press **Stop/Exit**.

Using the temporary Copy key

When you want to quickly change the copy settings temporarily for the next copy, use the **Options** key. You can use different combinations.

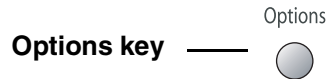



Note

- These settings are temporary, and the machine returns to its default settings 60 seconds after it finishes copying, unless you have set the Mode Timer to 30 seconds or less. (See *Setting the Mode Timer (FAX-2820 and FAX-2920 only)* on page 2-3 or *Setting the Mode Timer (MFC-7220 and MFC-7225N only)* on page 2-3.)
- You can save the copy settings you use most often by setting them as default. (See *Changing the default copy settings* on page 8-7.)

Using the Options key

Use the **Options** key to quickly set the following copy settings temporarily for the next copy.

Press 	Menu Selections 	Options 	Page
	Enlarge/Reduce	50%/70%/78%/83%/ 85%/91%/94%/97%/ 100% / 104%/141%/200%/ Custom (50-200%)/Auto	8-4
	Quality	Auto Text Photo	8-5
	Stack/Sort	Stack Sort	8-5
	Contrast	▼ -□□□□■+ ▲ ▼ -□□□■□+ ▲ ▼ -□□■□□+ ▲ ▼ -□■□□□+ ▲ ▼ -■□□□□+ ▲	8-5
	Page Layout	Off (1 in 1) 2 in 1 (P) 2 in 1 (L) 4 in 1 (P) 4 in 1 (L)	8-6



Note

The factory settings are shown in Bold.

After you choose your settings by pressing **Menu/Set**, the LCD shows **Set** temporarily.

Press **Start** if you have finished choosing settings.

Enlarging or reducing the image copied

You can select the following enlargement or reduction ratios.

Auto sets the machine to calculate the reduction ratio that fits the size of your paper.

Custom (50-200%) allows you to enter a ratio from 50% to 200%.

Press  and ▲ or ▼ to select Enlarge/Reduce	100%
	104% EXE→LTR
	141% A5→A4
	200%
	Auto
	Custom(50-200%)
	50%
	70% A4→A5
	78% LGL→LTR
	83% LGL→A4
	85% LTR→EXE
	91% Full Page
	94% A4→LTR
	97% LTR→A4

- 1 Press  (**Copy**) to illuminate it in green.
- 2 Load your document.
- 3 Use the dial pad to enter the number of copies you want (up to 99).
- 4 Press **Options** and **▲** or **▼** to select **Enlarge/Reduce**.
Press **Menu/Set**.

- 5 Press **▲** or **▼** to select the enlargement or reduction ratio you want.

Press **Menu/Set**.

—OR—

Use the dial pad to enter an enlargement or reduction ratio from 50% to 200%.

Press **Menu/Set**.

(For example, press **5 3** to enter 53%.)

- 6 Press **Start**.



Note

Special Copy Options 2in1(P), 2in1(L), 4in1(P) or 4in1(L) are not available with Enlarge/Reduce.



Quality

You can select the copy quality. The default setting is *Auto*.

Auto	Suitable for documents that contain both text and photographs.
Text	Suitable for documents containing only text.
Photo	Suitable for copying photographs.

- 1 Press  (**Copy**) to illuminate it in green.
- 2 Load your document.
- 3 Use the dial pad to enter the number of copies you want (up to 99).
- 4 Press **Options** and ▲ or ▼ to select *Quality*.
Press **Menu/Set**.
- 5 Press ▲ or ▼ to select the copy quality you want (*Auto*, *Text* or *Photo*).
Press **Menu/Set**.
- 6 Press **Start**.

Sorting copies using the ADF

You can sort multiple copies. Pages will be stacked in the order  (1 2 3),  (1 2 3) and so on.

- 1 Press  (**Copy**) to illuminate it in green.
- 2 Load your document.
- 3 Use the dial pad to enter the number of copies you want (up to 99).
- 4 Press **Options** and ▲ or ▼ to select *Stack/Sort*.
Press **Menu/Set**.
- 5 Press ▲ or ▼ to select *Sort*.
Press **Menu/Set**.
- 6 Press **Start**.

Contrast

You can adjust copy contrast to make copies darker or lighter.

- 1 Press  (**Copy**) to illuminate it in green.
- 2 Load your document.
- 3 Use the dial pad to enter the number of copies you want (up to 99).
- 4 Press **Options** and ▲ or ▼ to select *Contrast*.
Press **Menu/Set**.
- 5 Press ▲ to increase the contrast.
—OR—
Press ▼ to decrease the contrast.
Press **Menu/Set**.
- 6 Press **Start**.

Making N in 1 copies (Page Layout)

You can reduce the amount of copies by using the N in 1 copy feature. This allows you to copy two or four pages onto one page, allowing you to save paper.



Note

- Please make sure paper size is set to Letter, Legal or A4.
- You can use N in 1 copy feature with 100% copy size only.
- (P) means Portrait and (L) means Landscape.

- 1 Press (**Copy**) to illuminate it in green.
- 2 Load your document.
- 3 Use the dial pad to enter the number of copies you want (up to 99).
- 4 Press **Options** and ▲ or ▼ to select Page Layout.
Press **Menu/Set**.
- 5 Press ▲ or ▼ to select 2 in 1 (P), 2 in 1 (L), 4 in 1 (P) or 4 in 1 (L).
Press **Menu/Set**.
- 6 Press **Start** to scan the document.

When using the ADF, place document face down in the direction shown below.

2 in 1 (P)

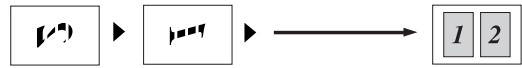

2 in 1 (L)

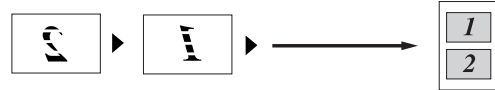

4 in 1 (P)



4 in 1 (L)



Changing the default copy settings

You can save the copy settings you use most often by setting them as default. These settings will remain until you change them again.

Quality

- 1 Press **Menu/Set**, 3, 1.

1.Quality

- 2 Press ▲ or ▼ to select **Auto**, **Text** or **Photo**.
Press **Menu/Set**.

- 3 Press **Stop/Exit**.

Adjusting contrast

You can change the contrast to help an image look sharper and more vivid.

- 1 Press **Menu/Set**, 3, 2.

2.Contrast

- 2 Press ▲ to increase the contrast.

—OR—

Press ▼ to decrease the contrast.

Press **Menu/Set**.

- 3 Press **Stop/Exit**.

Out of Memory message

If the memory becomes full while you are making copies, the LCD message will guide you through the next step.

If you get an **Out of Memory** message while scanning a subsequent page, you will have the option to press **Start** to copy the pages scanned so far, or to press **Stop/Exit** to cancel the operation.



Note

To gain extra memory, you can turn off Fax Storage.
(See *Turning off Remote Fax Options* on page 6-4.)

—OR—

Print the faxes that are in the memory.
(See *Printing a fax from the memory* on page 4-5.)

When you get an **Out of Memory** message, you may be able to make copies if you first print incoming faxes in the memory to restore the memory to 100%.

Software and Network Features (MFC-7220 and MFC-7225N only)

The User's Guide on the CD-ROM includes the Software and Network User's Guides* for features available when connected to a computer (for example, Printing and Scanning). The availability of the features listed below varies by model:

- Using the machine as a Printer
(See Chapter 1 in the Software User's Guide on the CD-ROM.)
- How to Scan
(See Chapter 2 in the Software User's Guide on the CD-ROM.)
- Using ControlCenter2.0
(See Chapter 3 in the Software User's Guide on the CD-ROM.)
- Using Remote Setup
(See Chapter 4 in the Software User's Guide on the CD-ROM.)
- Using Brother PC-FAX software
(See Chapter 5 in the Software User's Guide on the CD-ROM.)
- Network Scanning**
- Network Printing**



Note

See also *How to access the complete User's Guide (MFC-7220 and MFC-7225N only)* on page 1-3.

* The Network User's Guide is for the MFC-7225N only.

** For MFC-7220 (Optional NC-2200w External Wireless Print/Scan Server required)

For MFC-7225N (See the Software User's Guide on the CD-ROM.)

Standard telephone and FCC Notices

These notices are in effect on models sold and used in the United States only.

This equipment is hearing-aid compatible.

When programming emergency numbers or making test calls to emergency numbers:

- Remain on the line and briefly explain to the dispatcher the reason for the call before hanging up.
- Perform these activities in the off-peak hours, such as early morning or late evening.

This equipment complies with Part 68 of the FCC rules and the requirements adopted by the ACTA. On the backside of this equipment is a label that contains, among other information, a product identifier in the format US: AAAEQ##TXXXX. If requested, this number must be provided to the telephone company.

You may safely connect this equipment to the telephone line by means of a standard modular jack, USOC RJ11C.

A plug and jack used to connect this equipment to the premises wiring and telephone network must comply with the applicable FCC Part 68 rules and requirements adopted by the ACTA. A compliant telephone cord and modular plug is provided with this product. It is designed to be connected to a compatible modular jack that is also compliant. See installation instructions for details.

The REN is used to determine the number of devices that may be connected to a telephone line. Excessive RENs on a telephone line may result in the devices not ringing in response to an incoming call. In most but not all areas, the sum of RENs should not exceed five (5.0). To be certain of the number of devices that may be connected to a line, as determined by the total RENs, contact the local telephone company. For products approved after July 23, 2001, the REN for this product is part of the product identifier that has the format US:AAAEQ##TXXXX. The digits represented by ## are the REN without a decimal point (e.g., 06 is a REN of 0.6). For earlier products, the REN is separately shown on the label.

If this equipment causes harm to the telephone network, the telephone company will notify you in advance that temporary discontinuance of service may be required. But if advance notice isn't practical, the telephone company will notify the customer as soon as possible. Also, you will be advised of your right to file a complaint with the FCC if you believe it is necessary.

The telephone company may make changes in its facilities, equipment, operations or procedures that could affect the operation of the equipment. If this happens the telephone company will provide advance notice in order for you to make necessary modifications to maintain uninterrupted service.

If trouble is experienced with this equipment, for repair or warranty information, please contact Brother Customer Service. (See *Brother numbers* on page i.) If the equipment is causing harm to the telephone network, the telephone company may request that you disconnect the equipment until the problem is resolved.

Connection to party line service is subject to state tariffs. Contact the state public utility commission, public service commission or corporation commission for information.

If your home has specially wired alarm equipment connected to the telephone line, ensure the installation of this equipment does not disable your alarm equipment. If you have questions about what will disable alarm equipment, call your telephone company or a qualified installer.

If you are not able to solve a problem with your machine, call Brother Customer Service. (See *Brother numbers* on page i.)



WARNING

- For protection against the risk of electrical shock, always disconnect all cables from the wall outlet before servicing, modifying or installing the equipment.
- This equipment may not be used on coin service lines provided by the telephone company or connected to party lines.
- Brother cannot accept any financial or other responsibilities that may be the result of your use of this information, including direct, special or consequential damages. There are no warranties extended or granted by this document.
- This machine has been certified to comply with FCC standards, which are applied to the USA only. A grounded plug should be plugged into a grounded AC power outlet after checking the rating of the local power supply for the machine to operate properly and safely.

Federal Communications Commission (FCC) Declaration of Conformity (USA only)

Responsible Party:

Brother International Corporation
100 Somerset Corporate Boulevard
Bridgewater, NJ 08807-0911 USA
TEL: (908) 704-1700

declares, that the products

Product Name:

FAX-2820, FAX-2920, MFC-7220 and
MFC-7225N

comply with Part 15 of the FCC Rules. Operation is subject to the following two conditions: (1) This device may not cause harmful interference, and (2) this device must accept any interference received, including interference that may cause undesired operation.

This equipment has been tested and found to comply with the limits for a Class B digital device, pursuant to Part 15 of the FCC Rules. These limits are designed to provide reasonable protection against harmful interference in a residential installation. This equipment generates, uses, and can radiate radio frequency energy and, if not installed and used in accordance with the instructions, may cause harmful interference to radio communications. However, there is no guarantee that interference will not occur in a particular installation. If this equipment does cause harmful interference to radio or television reception, which can be determined by turning the equipment off and on, the user is encouraged to try to correct the interference by one or more of the following measures:

- Reorient or relocate the receiving antenna.
- Increase the separation between the equipment and receiver.
- Connect the equipment into an outlet on a circuit different from that to which the receiver is connected.
- Call the dealer or an experienced radio/TV technician for help.

Important

Changes or modifications not expressly approved by Brother Industries, Ltd. could void the user's authority to operate the equipment.

Important - about the interface cable

A shield interface cable should be used to ensure compliance with the limits for a Class B digital device.

Industry Canada Compliance Statement (Canada only)

This Class B digital apparatus complies with Canadian ICES-003.

Cet appareil numérique de la classe B est conforme à la norme NMB-003 du Canada.

Disconnect device

This product must be installed near an AC power outlet that is easily accessible. In case of emergencies, you must disconnect the power cord from the AC power outlet to shut off power completely.

LAN connection (MFC-7225N only)

! CAUTION

Do not connect this product to a LAN connection that is subject to over-voltages.

International ENERGY STAR® Compliance Statement

The purpose of the International ENERGY STAR® Program is to promote the development and popularization of energy-efficient office equipment.

As an ENERGY STAR® Partner, Brother Industries, Ltd. has determined that this product meets the ENERGY STAR® guidelines for energy efficiency.



Laser safety

This equipment is certified as a Class 1 laser product under the U.S. Department of Health and Human Services (DHHS) Radiation Performance Standard according to the Radiation Control for Health and Safety Act of 1968. This means that the equipment does not produce hazardous laser radiation.

Since radiation emitted inside the equipment is completely confined within protective housings and external covers, the laser beam cannot escape from the machine during any phase of user operation.

FDA regulations

U.S. Food and Drug Administration (FDA) has implemented regulations for laser products manufactured on and after August 2, 1976. Compliance is mandatory for products marketed in the United States. The following label on the back of the machine indicates compliance with the FDA regulations and must be attached to laser products marketed in the United States.

Manufactured:

BROTHER CORP. (ASIA) LTD.
BROTHER BUJI NAN LING FACTORY
Gold Garden Industry, Nan Ling Village, Buji,
Rong Gang, Shenzhen, China.

This product complies with FDA performance standards for laser products except for deviations pursuant to Laser Notice No. 50, dated July 26, 2001.

! WARNING

Use of controls, adjustments or performance of procedures other than those specified in this manual may result in hazardous invisible radiation exposure.

Internal laser radiation

Max. Radiation Power 5 mW

Wave Length 770 - 810 nm

Laser Class Class 3B

Important safety instructions

- 1 Read all of these instructions.
- 2 Save them for later reference.
- 3 Follow all warnings and instructions marked on the product.
- 4 Unplug this product from the wall outlet before cleaning inside of the machine. Do not use liquid or aerosol cleaners. Use a damp cloth for cleaning.
- 5 Do not place this product on an unstable cart, stand, or table. The product may fall, causing serious damage to the product.
- 6 Slots and openings in the cabinet and the back or bottom are provided for ventilation; to ensure reliable operation of the product and to protect it from overheating, these openings must not be blocked or covered. The openings should never be blocked by placing the product on a bed, sofa, rug, or other similar surface. This product should never be placed near or over a radiator or heater. This product should never be placed in a built-in installation unless proper ventilation is provided.
- 7 This product should be operated from the type of power source indicated on the label. If you are not sure of the type of power available, call your dealer or local power company.
- 8 This product is equipped with a 3-wire grounded plug. This plug will only fit into a grounded power outlet. This is a safety feature. If you are unable to insert the plug into the outlet, call your electrician to replace your obsolete outlet. Do not defeat the purpose of the grounded plug.
- 9 Do not allow anything to rest on the power cord. Do not place this product where people can walk on the cord.
- 10 If an extension cord is used with this product, make sure that the total ampere ratings on the products plugged into the extension cord do not exceed the extension cord ampere rating. Also, make sure that the total of all products plugged into the AC power outlet does not exceed 15 amperes (USA only).
- 11 Do not place anything in front of the machine that will block received faxes. Do not place anything in the path of received faxes.
- 12 Wait until pages have exited the machine before picking them up.
- 13 Never push objects of any kind into this product through cabinet slots, since they may touch dangerous voltage points or short out parts resulting in the risk of fire or electric shock. Never spill liquid of any kind on the product. Do not attempt to service this product yourself because opening or removing covers may expose you to dangerous voltage points and other risks and may void your warranty. Refer all servicing to a Brother Authorized Service Center. For the location of your nearest Brother Authorized Service Center, please call,
In USA: 1-800-284-4357 or
In Canada: 1-877-BROTHER.
(See *Brother numbers* on page i.)

- 14 Unplug this product from the AC power outlet and refer all servicing to Brother Authorized Service Personnel under the following conditions:
- When the power cord is damaged or frayed.
 - If liquid has been spilled into the product.
 - If the product has been exposed to rain or water.
 - If the product does not operate normally when the operating instructions are followed. Adjust only those controls that are covered by the operating instructions. Improper adjustment of other controls may result in damage and will often require extensive work by a qualified technician to restore the product to normal operation.
 - If the product has been dropped or the cabinet has been damaged.
 - If the product exhibits a distinct change in performance, indicating a need for service.
- 15 To protect your product against power surges, we recommend the use of a power protection device (Surge Protector).
- 16 To reduce the risk of fire, electric shock and injury to people, note the following:
- Do not use this product near appliances that use water, a swimming pool or in a wet basement.
 - Do not use the machine's telephone during an electrical storm (there is the remote possibility of an electrical shock) or to report a gas leak in the vicinity of the leak.
 - Do not dispose of batteries in a fire. They may explode. Check with local codes for possible special disposal instructions.
- 17 Caution - To reduce the risk of fire, use only No.26 AWG or larger telecommunication line cord.

Trademarks

The Brother logo is a registered trademark of Brother Industries, Ltd.

Brother is a registered trademark of Brother Industries, Ltd.

Multi-Function Link is a registered trademark of Brother International Corporation.

© 2004-2005 Brother Industries, Ltd. All rights reserved.

Windows and Microsoft are registered trademarks of Microsoft in the U.S. and other countries.

Macintosh and TrueType are registered trademarks of Apple Computer, Inc.

PaperPort and OmniPage OCR are registered trademarks of ScanSoft, Inc.

Presto! PageManager is a registered trademark of NewSoft Technology Corporation.

Each company whose software title is mentioned in this manual has a Software License Agreement specific to its proprietary programs.

All other brand and product names mentioned in this User's Guide, the Software User's Guide* and the Network User's Guide MFC-7220 and are registered trademarks of their respective companies.**

* MFC-7220 and MFC-7225N

** MFC-7220 (option)
MFC-7225N (included)

Troubleshooting

IMPORTANT

For technical help, you must call the country where you bought the machine. Calls must be made **from within** that country.

Error messages

As with any sophisticated office product, errors may occur. If this happens, your machine identifies the problem and displays an error message. The most common error messages are shown below.

You can correct most problems by yourself. If you need more help, the Brother Solutions Center offers latest FAQs and troubleshooting tips.

Visit us at <http://solutions.brother.com>.

ERROR MESSAGES		
ERROR MESSAGE	CAUSE	ACTION
Back Cover Open	The back cover is not completely closed.	Close the back cover of the machine.
Change Drum Soon	The drum unit is near the end of its life	Use the drum unit until you have a print quality problem; then replace the drum unit with a new one. See <i>Replacing the drum unit (DR-350)</i> on page 11-27.
Comm. Error	Poor phone line quality caused a communication error.	Send the fax again or connect the machine to another telephone line. If the problem continues, call the telephone company and ask them to check your phone line.
Connection Fail	You tried to poll a fax machine that is not in Polled Waiting mode.	Check the other fax machine's polling setup.
Cooling Down Wait for a while	The temperature of the drum unit or toner cartridge is too hot. The machine will pause its current print job and go into cooling down mode. During the cooling down mode, you will hear the cooling fan running while the display on the machine shows <i>Cooling Down</i> , and <i>Wait for a while</i> .	You must wait 20 minutes for it to cool.
Cover is Open	The front cover is not completely closed.	Close the front cover of the machine.

ERROR MESSAGES		
ERROR MESSAGE	CAUSE	ACTION
Data Remaining	Print data is left in the machine's memory.	Re-start printing from your computer.
	(MFC-7220 and MFC-7225N only) Print data is left in the machine's memory. The USB or Parallel cable was unplugged while the computer was sending the data to the machine.	Press Job Cancel . The machine will cancel the job and clear it from the memory. Try to print again.
Disconnected	The other person or other person's fax machine stopped the call.	Try to send or receive again.
Document Jam	The document was not inserted or fed properly, or the document scanned from the ADF was too long.	See <i>Document jams</i> on page 11-7. See <i>Using the automatic document feeder (ADF)</i> on page 1-7.
DR Mode in Use	The machine is set to Distinctive Ring mode. You can not change the Receive Mode from Manual to another mode.	Set Distinctive Ring to Off . See <i>Turning off the Distinctive Ring</i> on page A-2.
Dust on Drum	The drum unit needs to be cleaned.	See <i>Cleaning the drum unit</i> on page 11-17.
Fail to Warm up	The fuser unit is too cold.	(For FAX-2820 and MFC-7220)
Unit is too Hot	The fuser unit is too hot.	When you turn off the machine's power switch, its memory will be cleared. (To check if faxes are in the machine's memory, see <i>Checking if the machine has faxes in its memory</i> on page 11-6.) If there are faxes, you need to save them before following the suggestions below. (To save the faxes, see <i>Forwarding faxes to another fax machine</i> on page 11-6.) For MFC-7220 also see <i>Transferring faxes to your PC (MFC-7220 and MFC-7225N only)</i> on page 11-6. Then, turn off the machine's power switch. Check the machine's environment. If it is in a location that is too hot or too cold, try to cool or warm the room by turning on the air conditioner or heater. Or, move the machine to another location. Then, turn on the machine's power switch. (For FAX-2920 and MFC-7225N) Turn off the machine's power switch, and check the machine's environment. If it is in a location that is too hot or too cold, try to cool or warm the room by turning on the air conditioner or heater. Or, change the location. Then, turn on the machine's power switch. (The machine can be disconnected for up to 4 days without losing faxes stored in the memory.)

ERROR MESSAGES		
ERROR MESSAGE	CAUSE	ACTION
Machine too Hot	The inside of the machine is too hot.	<p>Make sure you can hear the fan in the machine spinning and the exhaust outlet isn't blocked by something.</p> <p>If the fan is spinning, remove any obstacles that surround the exhaust outlet, and then leave the machine turned on but do not use it for several minutes.</p> <p>If the fan is not spinning, you need to save the faxes before you follow the suggestions below.</p> <p>(For FAX-2820 and MFC-7220)</p> <p>When you turn off the machine's power switch its memory will be cleared. To check whether the machine has faxes in its memory see <i>Checking if the machine has faxes in its memory</i> on page 11-6. If there are faxes you need to save them before following the suggestions below (To save the faxes, see <i>Forwarding faxes to another fax machine</i> on page 11-6. For MFC-7220 also see <i>Transferring faxes to your PC (MFC-7220 and MFC-7225N only)</i> on page 11-6).</p> <p>Turn off the machine's power switch and then turn it on again. If the error message continues, leave the machine for several minutes and try it again.</p> <p>(For FAX-2920 and MFC-7225N)</p> <p>Turn off the machine's power switch and then turn it on again. If the error message continues leave the machine for several minutes and then try it again. (The machine can be turned off for up to 4 days without losing faxes stored in the memory.)</p>
No cartridge	The toner cartridge is not installed properly.	Reinstall the toner cartridge.
No Paper Fed	The machine is out of paper or paper is not properly loaded in the paper tray.	<p>Refill the paper in the paper tray and then press Start.</p> <p>—OR—</p> <p>Remove the paper and load it again and then press Start.</p>
No Response/Busy	The number you dialed does not answer or is busy.	Verify the number and try again.
Not Registered	You tried to access a One-Touch or Speed Dial number that is not programmed.	Set up the One-Touch or Speed Dial number. (See <i>Storing One-Touch numbers</i> on page 5-1 and <i>Storing Speed-Dial numbers</i> on page 5-2.)

ERROR MESSAGES		
ERROR MESSAGE	CAUSE	ACTION
Out of Memory	The machine's memory is full.	<p>(Fax sending or copy operation in progress) Press Start to send or copy the scanned pages. —OR— Press Stop/Exit and wait until the other operations in progress have finished and then try again. —OR— Clear the faxes from the memory. (See <i>Out of Memory message</i> on page 8-7.)</p> <p>(Printing operation in process) Reduce print resolution. (For details <i>Advanced tab</i> in the Software User's Guide on the CD-ROM.) (FAX-2820 only: For details regarding print resolution and printer memory, please see the Printer Manual which can be downloaded from the solutions.brother.com Web site.) —OR— Clear the faxes from the memory. (See <i>Out of Memory message</i> on page 8-7.)</p>
Paper jam Inside	The paper is jammed inside the machine.	(See <i>Paper jams</i> on page 11-7.)
Paper Jam Rear	The paper is jammed in the back of the machine.	(See <i>Paper jams</i> on page 11-7.)
Paper Jam Tray	The paper is jammed in the paper tray of machine.	(See <i>Paper jams</i> on page 11-7.)
Toner Life End	<p>The toner cartridge and drum unit assembly is not installed or it is not installed properly. —OR— The toner is used up and printing is not possible.</p>	<p>Re-install the toner cartridge and drum unit assembly. —OR— Replace the toner cartridge with a new one. (See <i>Replacing the toner cartridge (TN-350)</i> on page 11-24.)</p>
Toner Low	The toner cartridge is near the end of its life and the toner will soon run out.	Order a new toner cartridge now.

ERROR MESSAGES		
ERROR MESSAGE	CAUSE	ACTION
Unable to Init. (Initialize) Unable to Print Unable to Scan	The machine has a mechanical problem.	<p>(For FAX-2820 and MFC-7220) When you turn off the machine's power switch its memory will be cleared. To check whether the machine has faxes in its memory see <i>Checking if the machine has faxes in its memory</i> on page 11-6. If there are faxes you need to save them before following the suggestions below (To save the faxes, see <i>Forwarding faxes to another fax machine</i> on page 11-6. For MFC-7220 also see <i>Transferring faxes to your PC (MFC-7220 and MFC-7225N only)</i> on page 11-6).</p> <p>Turn off the machine's power switch and then turn it on again. If the error message continues, leave the machine for several minutes and try it again.</p> <p>(For FAX-2920 and MFC-7225N) Turn off the machine's power switch and then turn it on again. If the error message continues leave the machine for several minutes and then try it again. (The machine can be turned off for up to 4 days without losing faxes stored in the memory.)</p>
Wrong Paper Size	Paper is not the correct size.	Load the correct size of paper (Letter, Legal or A4) and then press Start .

Checking if the machine has faxes in its memory

- 1 Press **Menu/Set**, **9, 0, 1**.
- 2 If the LCD shows `No Data`, there are no faxes left in the machine's memory.

—OR—

If the LCD shows `Enter Fax No.` there are faxes in the machine's memory.

- You can transfer the faxes to another fax machine. See *Forwarding faxes to another fax machine* on this page.
- (MFC-7220 and MFC-7225N only)
You can transfer the faxes from the machine's memory to your PC. See *Transferring faxes to your PC (MFC-7220 and MFC-7225N only)* on this page.

Forwarding faxes to another fax machine

If you have not set up your Station ID you cannot enter fax forward mode. (See *Setting the Station ID* on page 2-2.)

- 1 Enter the fax number to which the faxes will be forwarded.
- 2 Press **Start**.



Note

You can transfer the Fax Journal report to another fax machine by pressing **Menu/Set**, **9, 0, 2** in Step 1.

Transferring faxes to your PC (MFC-7220 and MFC-7225N only)

You can transfer the faxes from your machine's memory to your PC.

- 1 Press **Stop/Exit**.
- 2 Make sure you have installed **MFL Pro Suite** on your PC, and then turn on **PC Fax Receiving** on the PC. (For details about PC Fax Receive, see Using Brother PC-Fax Software in the Software User's Guide on the CD-ROM.)
- 3 Make sure you have set `PC Fax Receive` on the machine. (See *Setting PC Fax Receive (MFC-7220 and MFC-7225N only)* on page 6-3.)
During setup the LCD will ask if you want to transfer the faxes to your PC.
- 4 To transfer all faxes to your PC, press **1**.
—OR—
To exit and leave the faxes in the memory, press **2**.



Note

If there is an error on the machine's LCD, after the faxes have been transferred disconnect the machine from the power source for several minutes, and then reconnect it.

Document jams

If the document is jammed, follow the steps below.

Document was not inserted or fed properly, or was too long

- 1 Open the control panel cover.

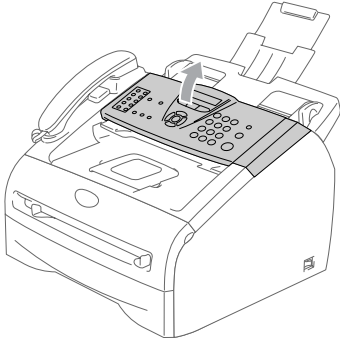

- 2 Carefully pull the jammed document toward the front of the machine.

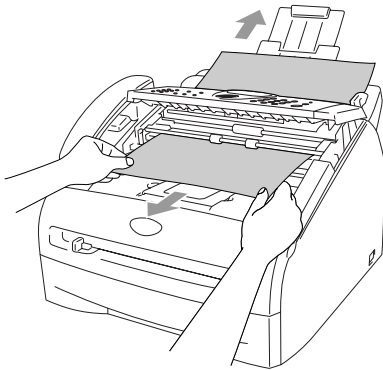

- 3 Close the control panel cover. Press **Stop/Exit**.

Paper jams

To clear paper jams, please follow the steps in this section.

! WARNING

 After you have just used the machine, some parts inside the machine are extremely hot. When you open the front cover or back cover of the machine, never touch the shaded parts shown in the following diagram.

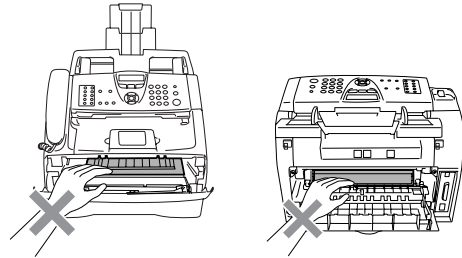

Paper is jammed inside the machine

- 1 Pull the paper tray completely out of the machine.
- 2 Pull the jammed paper out of the paper tray opening.

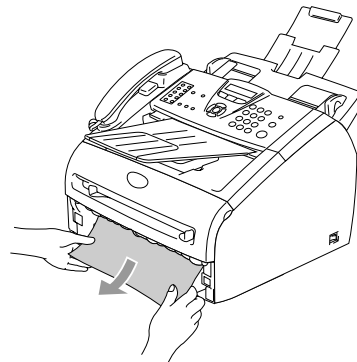

- 3 Open the front cover.

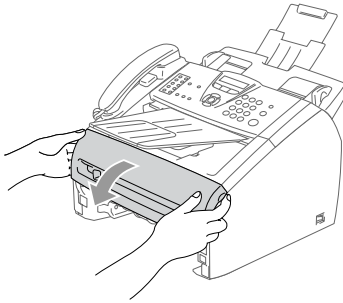

- 4 Pull out the drum unit and toner cartridge assembly. The jammed paper may be pulled out with the toner cartridge and drum unit assembly, or this may release the paper so you can pull it out of the paper tray opening.

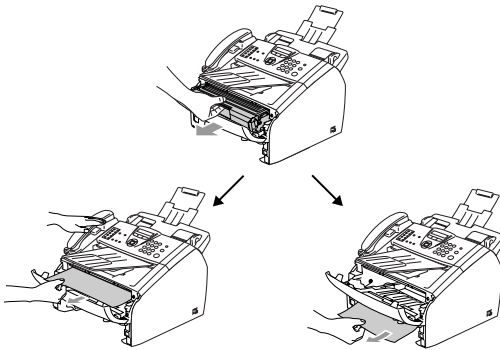

- 5 Put the drum unit and toner cartridge assembly back into the machine.

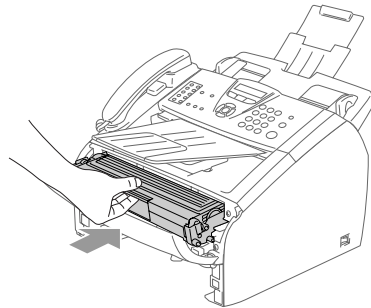

- 6 Close the front cover.

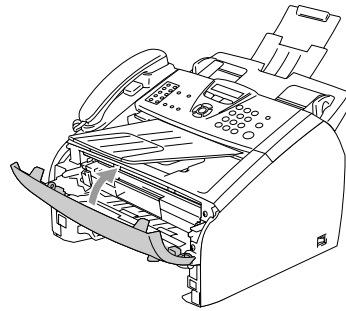

- 7 Put the paper tray in the machine.

! CAUTION

To prevent damage to the machine caused by static electricity, do not touch the electrodes shown in the following diagram.

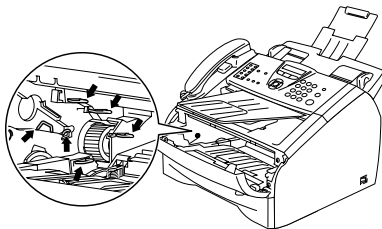

Paper is jammed at the back of the machine

- 1 Open the front cover.

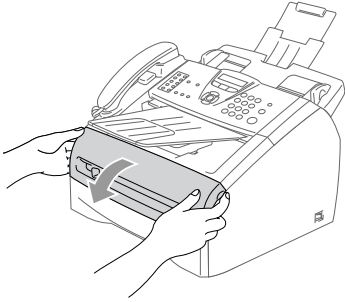

- 2 Pull out the drum unit and toner cartridge assembly.

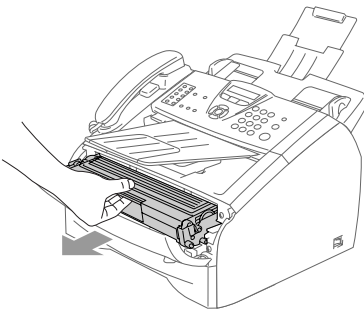

- 3 Open the back cover.

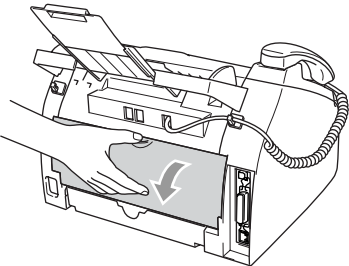

- 4 Pull the tab toward you to open the rear chute cover.

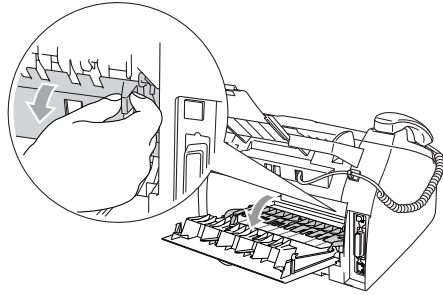

- 5 Pull the jammed paper out of the fuser unit. If the jammed paper cannot be pulled out easily, push down on the blue tab with one hand as you gently pull out the paper with the other hand.

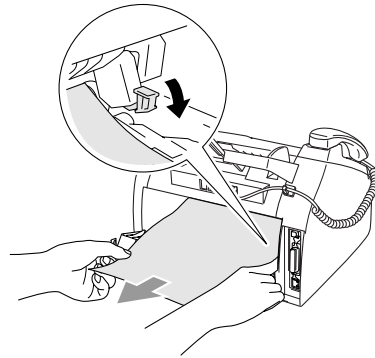

- 6 Close the back cover.

- 7 Put the drum unit and toner cartridge assembly back into the machine.

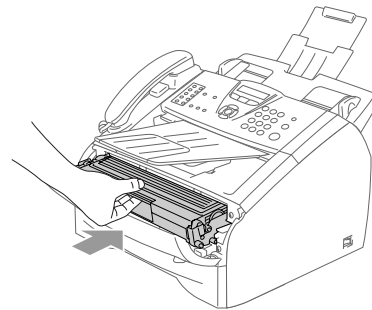

- 8 Close the front cover.

Paper is jammed inside the drum unit and toner cartridge assembly

- 1 Open the front cover.

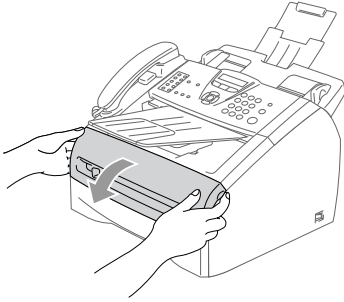

- 2 Pull out the drum unit and toner cartridge assembly.

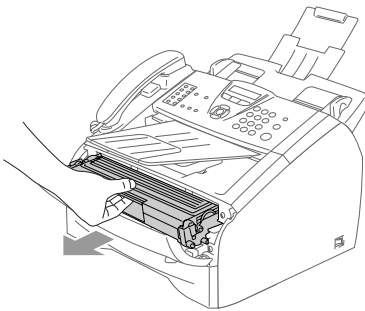

- 3 Hold down the lock lever on the left and pull the toner cartridge out of the drum unit. Take out the jammed paper if there is any inside the drum unit.

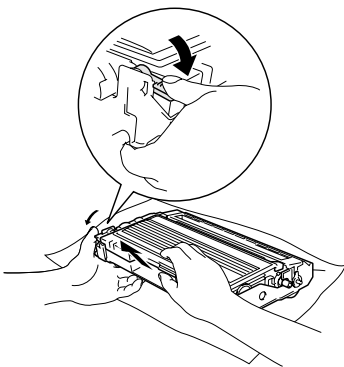

- 4 Put the toner cartridge back into the drum unit until you hear it lock into place. If you put it in properly, the lock lever will lift automatically.

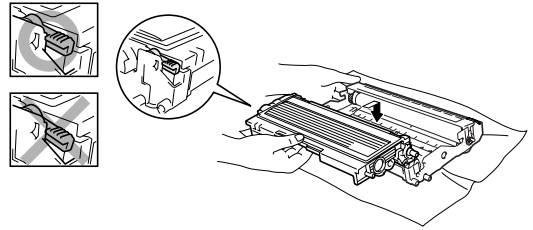

- 5 Put the drum unit and toner cartridge assembly back into the machine.

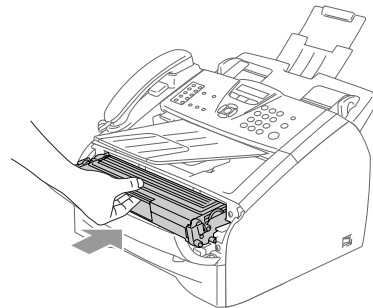

- 6 Close the front cover.

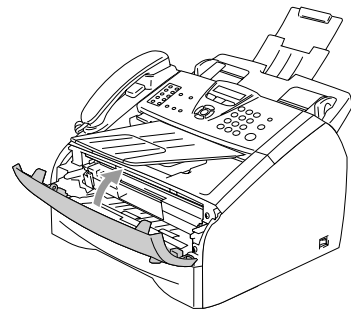

If you are having difficulty with your machine

If you think there is a problem with the way your faxes look, make a copy first. If the copy looks good, the problem is probably not your machine. Check the chart below and follow the troubleshooting tips.

The Brother Solutions Center offers the latest FAQs and troubleshooting tips.

Visit us at <http://solutions.brother.com>.

DIFFICULTY	SUGGESTIONS
Printing or Receiving Faxes	
Condensed print and horizontal streaks or the top and bottom of sentences are cut off.	You probably had a bad connection, with static or interference on the telephone line. Ask the other party to send the fax again. If there is still a problem, call Brother Customer Service at 1-800-284-4329 (in USA) or 1-877-BROTHER (in Canada).
Poor print quality	See <i>Improving the print quality</i> on page 11-16.
Vertical black lines when receiving	Sometimes you may see vertical streaks/black lines on the faxes you receive. Your machine's primary corona wire may be dirty, or the sending party's fax scanner may be dirty. Clean your primary corona wire (See <i>Cleaning the corona wire</i> on page 11-24), or ask the sender to make a copy to see if the problem is with the sending machine. Try receiving from another fax machine. If the problem continues, call Brother Customer Service at 1-800-284-4329 (in USA) or 1-877-BROTHER (in Canada).
Horizontal streaks; lines are missing.	You may get a fax with horizontal streaks or with missing lines. Usually this is caused by a poor telephone connection. Ask the other party to send the fax again.
Received faxes appear as split or blank pages.	If the received faxes are divided and printed on two pages or if you get an extra blank page, your Paper Size setting may not be correct for the paper you are using. (See <i>Setting the Paper Size</i> on page 2-4.) Make sure that auto reduction menu setting is turned on. (See <i>Printing a reduced incoming fax (Auto Reduction)</i> on page 4-4.)
Phone Line or Connections	
Dialing does not work.	Check for a dial tone. Change Tone/Pulse setting. (See <i>Tone or Pulse (For Canada only)</i> on page 5-4.) Check all line cord connections and that the curled handset cord is not in the EXT jack. Check power cord connection. Send a manual fax by pressing Hook/Hold or by lifting the handset of the external phone and dialing the number. Send a manual fax by lifting the handset and dialing the number. Wait to hear fax receiving tones before pressing Start .
The machine does not answer when called.	Make sure the machine is in the correct receiving mode for your setup. (See <i>Basic sending operations</i> on page 3-4.) Check for a dial tone. If possible, call your machine to hear it answer. If there is still no answer, check the telephone line cord connection. If there is no ringing when you call your machine, ask your telephone company to check the line.
Sending Faxes	
Poor fax send quality	Change your resolution to Fine or S.Fine . Make a copy to check your machine's scanner operation. If the copy quality is not good, clean the scanner. (See <i>Cleaning the scanner glass</i> on page 11-22.)







DIFFICULTY	SUGGESTIONS
Transmission Verification Report says 'RESULT:NG' or 'RESULT:ERROR'.	<p>There is probably temporary noise or static on the line. Try sending the fax again. If you send a PC FAX message and get 'RESULT:NG' on the Transmission Verification Report, your machine may be out of memory. To gain extra memory, you can turn off Fax Storage (See <i>Turning off Remote Fax Options</i> on page 6-4), print fax messages in memory (See <i>Printing a fax from the memory</i> on page 4-5) or cancel a Delayed Fax or Polling Job (See <i>Canceling a fax in progress</i> on page 3-8). If the problem continues, ask the telephone company to check your phone line.</p> <p>If you frequently get transmission errors due to possible interference on the phone line, try changing the Compatibility setting to Basic. (See <i>Compatibility</i> on page 11-20.)</p>
Vertical black lines when sending.	If the copy you made shows the same problem, your scanner is dirty. (See <i>Cleaning the scanner glass</i> on page 11-22.)
Handling Incoming Calls	
The machine 'Hears' Voice as CNG Tone.	If Easy Receive is set to On , your machine is more sensitive to sounds. It may mistakenly interpret certain voices or music on the line as a calling fax machine and respond with fax receiving tones. Deactivate the machine by pressing Stop/Exit . Try avoiding this problem by turning Easy Receive to Off . (See <i>Easy Receive</i> on page 4-3.)
Sending a Fax Call to the machine.	If you answered at the machine, press Start and hang up immediately. If you answered on an external or extension phone, press your Fax Receive Code (default setting is (✕)51). When your machine answers, hang up.
Custom features on a single line.	<p>If you have Call Waiting, Call Waiting/Caller ID, RingMaster, Voice Mail, an answering machine, an alarm system or other custom feature on a single phone line with your machine, it may create a problem sending or receiving faxes.</p> <p>For Example: Your Brother machine handles the Caller ID subscriber services. However, if you subscribe to Call Waiting or some other custom service and its signal comes through the line while your machine is sending or receiving a fax, the signal can temporarily interrupt or disrupt the faxes. Brother's ECM feature should help overcome this problem. This condition is related to the telephone system industry and is common to all devices that send and receive information on a single, shared line with custom features. If avoiding a slight interruption is crucial to your business, a separate line with no custom features is recommended.</p>
Menu Setting Difficulties	
The machine beeps when you try to access the Setup Receive and Setup Send menus.	If the Fax  key is not illuminated, press it to turn on Fax mode. The Setup Receive setting (Menu/Set, 2, 1) and Setup Send setting (Menu/Set, 2, 2) are available only when the machine is in Fax mode.
Copy Quality Difficulties	
Vertical streaks appear in copies.	Sometimes you may see vertical streaks on your copies. Either the scanner or the primary corona wire is dirty. Clean them both. (See <i>Cleaning the scanner glass</i> on page 11-22, <i>Cleaning the laser scanner window</i> on page 11-22 and <i>Cleaning the drum unit</i> on page 11-17.)

DIFFICULTY	SUGGESTIONS
Printer Difficulties	
The machine does not print.	<p>Please make sure:</p> <ul style="list-style-type: none"> • The machine is plugged in and the power switch turned On. (See the Quick Setup Guide.) <p>—OR—</p> <ul style="list-style-type: none"> • The toner cartridge and drum unit are installed properly. (See <i>Replacing the drum unit (DR-350)</i> on page 11-27.) <p>—OR—</p> <ul style="list-style-type: none"> • The interface cable is securely connected between the machine and computer. (See the Quick Setup Guide.) <p>—OR—</p> <ul style="list-style-type: none"> • The correct printer driver has been installed and selected. <p>—OR—</p> <ul style="list-style-type: none"> • Check to see if the LCD is showing an error message. (See <i>Error messages</i> on page 11-1.) <p>—OR—</p> <ul style="list-style-type: none"> • The machine is online. Click Start and then Printers and Faxes. Right-click 'Brother MFC-XXXX,' (where XXXX is your model name). Make sure that "Use Printer Offline" is unchecked.
The machine prints unexpectedly or it prints garbage.	<p>(For FAX-2820 and MFC-7220)</p> <p>When you turn off the machine's power switch its memory will be cleared. To check whether the machine has faxes in its memory see <i>Checking if the machine has faxes in its memory</i> on page 11-6. If there are faxes you need to save them before following the suggestions below (See <i>Forwarding faxes to another fax machine</i> on page 11-6 or <i>Transferring faxes to your PC (MFC-7220 and MFC-7225N only)</i> on page 11-6).</p> <p>Turn off the machine's power switch and then turn it on again. If the error message continues, leave the machine for several minutes and try it again.</p> <p>Check the settings in your application software to make sure it is set up to work with your machine.</p> <p>(For FAX-2920 and MFC-7225N)</p> <p>Turn off the machine's power switch and then turn it on again. If the error message continues leave the machine for several minutes and then try it again. (The machine can be turned off for up to 4 days without losing faxes stored in the memory.)</p> <p>Check the settings in your application software to make sure it is set up to work with your machine.</p>
The machine prints first couple of pages correctly, then some pages have text missing.	Your computer is not recognizing the machine's input buffer full signal. Please make sure you connect the machine's cable correctly. (See the Quick Setup Guide.)
The machine cannot print full pages of a document. <i>Out of Memory</i> message occurs.	<p>Reduce the printing resolution. (See <i>Advanced tab</i> in Software User's Guide on the CD-ROM.)</p> <p>Reduce the complexity of your document and try again. Reduce the graphic quality or the number of font sizes within your application software.</p>
My headers or footers appear when I view my document on the screen but do not appear when I print them.	Your machine can print 62 lines per page. The top two lines and bottom two lines are a restricted area that will not accept print. Adjust the top and bottom margins in your document to allow for this.





DIFFICULTY	SUGGESTIONS
Scanning Difficulties (MFC-7220 and MFC-7225N only)	
TWAIN errors appear while scanning.	Make sure the Brother TWAIN driver is selected as the primary source. In PaperPort®, click Scan in the File menu and select the Brother TWAIN driver.
Software Difficulties (MFC-7220 and MFC-7225N only)	
Cannot install software or print.	Run the Repair MFL-Pro Suite program on the CD-ROM. This program will repair and reinstall the software.
Cannot perform '2 in 1' or '4 in 1' printing.	Check that the paper size setting in the application and in the printer driver are the same.
Machine does not print from Adobe Illustrator	Try to reduce the print resolution. (See <i>Advanced tab</i> in Software User's Guide on the CD-ROM.)
When using ATM fonts, some characters are missing or some characters are printed in their place.	If you are using Windows® 98/98SE/Me, select 'Printer Settings' from the 'Start' menu. Select the properties of the 'Brother MFC-7220 or MFC-7225N'. Click 'Spool Setting' on the 'Details' tab. Select 'RAW' from 'Spool Data Format.'
'Unable to write to LPT1' or 'LPT1 already in use' Error Message appears. (MFC-7220 and MFC-7225N only)	1. Make sure the machine is on (plugged into the AC power outlet and the power switch turned on) and that it is connected directly to the computer using the IEEE-1284 bi-directional parallel cable. The cable must not go through another peripheral device (such as a Zip Drive, External CD-ROM Drive, or Switch box).
'MFC is Busy' Error Message appears.	2. Make sure the machine is not displaying an error message on the LCD Display. 3. Make sure no other device drivers, which also communicate through the parallel port, are running automatically when you boot up the computer (such as, drivers for Zip Drives, External CD-ROM Drive, etc.) Suggested areas to check: (<i>Load=, Run=command lines in the win.ini file or the Setup Group</i>) 4. Check with your computer manufacturer to confirm that the computer's parallel port settings in the BIOS are set to support a bi-directional machine; i.e. (Parallel Port Mode – ECP)
Paper Handling Difficulties	
The machine does not feed paper. The LCD shows <i>No Paper Fed</i> or <i>Paper Jam</i> .	If there is no paper, load a new stack of paper into the paper tray. If there is paper in the paper tray, make sure it is straight. If the paper is curled, you should straighten it. Sometimes it is helpful to remove the paper, turn the stack over and put it back into the paper tray. Reduce the amount of paper in the paper tray, and then try again. Check that the manual feed mode is not selected in the printer driver. If the LCD shows <i>Paper Jam</i> and you still have a problem, see <i>Paper jams</i> on page 11-7.
The machine does not feed paper from the manual feed slot.	Reinsert the paper firmly, load one sheet at a time. Make sure that manual feed mode is selected in the printer driver.
How can I load envelopes?	You can load envelopes from the manual feed slot. Your application software must be set up to print the envelope size you are using. This is usually done in the Page Setup or Document Setup menu of your software. Please refer to the manual provided with your software application.
What paper can I use?	You can use plain paper, recycled paper, envelopes, transparencies and labels that are made for laser machines. (For information on paper you can use, see <i>About paper</i> on page 1-8.)
How can I clear paper jams?	See <i>Paper jams</i> on page 11-7.

DIFFICULTY	SUGGESTIONS
Print Quality Difficulties	
Printed pages are curled.	Low quality thin or thick paper can cause this problem. Make sure you select the Paper Type that suits the media type you use. (See <i>About paper</i> on page 1-8.)
Printed pages are smeared.	The Paper Type setting may be incorrect for the type of print media you are using— OR —The print media may be too thick or have a rough surface. (See <i>About paper</i> on page 1-8 and <i>Basic tab</i> in the Software User's Guide on the CD-ROM (MFC-7220 or MFC-7225N).)
Printouts are too light.	If this problem occurs when making copies or printing received faxes, turn off Toner Save mode in the machine itself. (See <i>Toner Save</i> on page 2-7.) Set Toner Save mode to off in the Advanced tab in the printer driver. (See <i>Advanced tab</i> in Software User's Guide on the CD-ROM (MFC-7220 or MFC-7225N).)
Network Difficulties (MFC-7225N only)	
I cannot print over the Network	Make sure that your machine is powered on and is online and in Ready mode. Print a Network Configuration list and check the current settings. (See <i>Printing reports</i> on page 7-1.) Reconnect the LAN cable to the hub to verify that the cabling and network connections are good. If possible, try connecting the machine to a different port on your hub using a different cable. If the connections are good, the machine shows LAN Active.

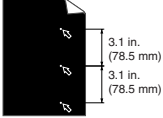
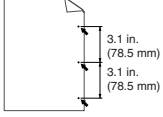
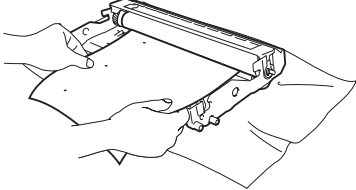
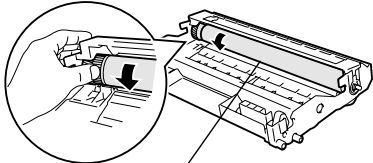
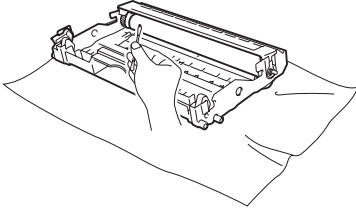
Improving the print quality

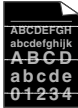
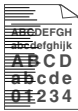
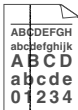
Examples of poor print quality	Recommendation
 <p>Faint</p>	<p>Check the machine's environment. Conditions such as humidity, high temperatures, and so on may cause this print fault. (See <i>Choosing a location</i> on page 1-2.)</p> <p>If the whole page is too light, Toner Save mode may be on. Turn off Toner Save mode in the Advanced tab of printer driver Properties.</p> <p>—OR—</p> <p>If this problem occurs when making copies or printing received faxes, turn off Toner Save mode in the machine itself. (See <i>Toner Save</i> on page 2-7.)</p> <p>Clean the scanner window and the primary corona wire on the drum unit. (See <i>Cleaning the laser scanner window</i> on page 11-22 and <i>Cleaning the corona wire</i> on page 11-24.) If the print quality has not improved, install a new drum unit. (See <i>Replacing the drum unit (DR-350)</i> on page 11-27.)</p> <p>Install a new toner cartridge. (See <i>Replacing the toner cartridge (TN-350)</i> on page 11-24.)</p>
 <p>Gray background</p>	<p>Make sure that you use paper that meets the recommended specifications. (See <i>About paper</i> on page 1-8.)</p> <p>Check the machine's environment - high temperatures and high humidity can increase the amount of background shading. (See <i>Choosing a location</i> on page 1-2.)</p> <p>Install a new toner cartridge. (See <i>Replacing the toner cartridge (TN-350)</i> on page 11-24.)</p> <p>Clean the primary corona wire on the drum unit. (See <i>Cleaning the corona wire</i> on page 11-24.) If the print quality has not improved, install a new drum unit. (See <i>Replacing the drum unit (DR-350)</i> on page 11-27.)</p>
 <p>Ghost</p>	<p>Make sure you use paper that meets our specifications. Rough-surfaced paper or thick print media may cause this problem.</p> <p>Make sure that you choose the appropriate media type in the printer driver or in the machine's Paper Type menu setting. (See <i>About paper</i> on page 1-8 and <i>Basic tab</i> in the Software User's Guide on the CD-ROM.)</p> <p>Install a new drum unit. (See <i>Replacing the drum unit (DR-350)</i> on page 11-27.)</p>
 <p>Toner specks</p>	<p>Make sure that you use paper that meets our specifications. Rough-surfaced paper may cause the problem. (See <i>About paper</i> on page 1-8.)</p> <p>Clean the primary corona wire and the drum unit. (See <i>Cleaning the corona wire</i> on page 11-24 and <i>Cleaning the drum unit</i> on page 11-17.) If the print quality has not improved, install a new drum unit. (See <i>Replacing the drum unit (DR-350)</i> on page 11-27.)</p>
 <p>Hollow print</p>	<p>Make sure that you use paper that meets our specifications. (See <i>About paper</i> on page 1-8.) Choose Thick paper mode in the printer driver or in the machine's Paper Type menu setting, or use thinner paper than you are currently using.</p> <p>Check the machine's environment because conditions such as high humidity can cause hollow print. (See <i>Choosing a location</i> on page 1-2.)</p> <p>Clean the primary corona wire on the drum unit. (See <i>Cleaning the corona wire</i> on page 11-24.) If the print quality has not improved, install a new drum unit. (See <i>Replacing the drum unit (DR-350)</i> on page 11-27.)</p>
 <p>All black</p>	<p>Clean the primary corona wire on the drum unit. (See <i>Cleaning the corona wire</i> on page 11-24.)</p> <p>If the print quality has not improved, install a new drum unit. (See <i>Replacing the drum unit (DR-350)</i> on page 11-27.)</p>

Examples of poor print quality	Recommendation
 <p>White Spots on black text and graphics at 3.1 in. (78.5 mm) intervals</p>  <p>Black Spots at 3.1 in. (78.5 mm) intervals</p>	<h2 data-bbox="463 258 875 297">Cleaning the drum unit</h2> <p data-bbox="463 314 1226 423">Dust, paper powder, glue, and so on may stick to the surface of the photosensitive drum (OPC) and cause black or white spots to appear on printed documents. Make a few copies of a blank, white sheet of paper. (See <i>Making multiple copies</i> on page 8-2.)</p> <p data-bbox="463 432 1226 483">If you still see the spots on printed documents after making multiple copies, clean the drum unit as follows:</p> <ol data-bbox="463 490 1226 598" style="list-style-type: none"> 1 Remove the drum unit and toner cartridge assembly, and then remove the toner cartridge from the drum unit. 2 Position the print sample in front of the drum unit so you will know the exact position on the drum that is causing the poor print.  <ol data-bbox="463 815 1226 846" style="list-style-type: none"> 3 Turn the black gear on the drum as you check the surface of the OPC drum. <p data-bbox="467 846 1163 877">! The OPC drum is photosensitive so do not touch it with your fingers.</p>  <p data-bbox="801 1051 979 1070">OPC drum surface</p> <ol data-bbox="463 1078 1226 1155" style="list-style-type: none"> 4 When you find the substance on the drum surface that matches the print sample, gently <i>dab</i> the surface of the OPC drum with a cotton swab that is lightly dampened with isopropyl alcohol. <p data-bbox="467 1163 1204 1213">! Do not use a scrubbing or wiping motion because this might damage the drum.</p>  <p data-bbox="467 1464 1226 1561">! Do not try to clean the surface of the OPC drum with a sharp object, such as a ball-point pen, because this might cause permanent damage to the drum unit.</p> <p data-bbox="463 1599 1136 1649">If the print quality still has not improved you need to install a new drum. (See <i>Replacing the drum unit (DR-350)</i> on page 11-27.)</p>

Examples of poor print quality	Recommendation
 <p>Black toner marks across the page</p>	<p>The drum unit may be damaged. Put in a new drum unit (See <i>Replacing the drum unit (DR-350)</i> on page 11-27.)</p> <p>Make sure that you use paper that meets our specifications. (See <i>About paper</i> on page 1-8.)</p> <p>If you use label sheets for laser printers, the glue from the sheets may sometimes stick to the OPC drum surface. Clean the drum unit. (See <i>Cleaning the drum unit</i> on page 11-17.)</p> <p>Do not use paper that has clips or staples because they will scratch the surface of the drum.</p> <p>If the unpacked drum unit is in direct sunlight or room light, the unit may be damaged.</p>
 <p>White lines across the page</p>	<p>Make sure that you use paper that meets our specifications. A rough surfaced paper or thick print media can cause the problem.</p> <p>Make sure that you choose the appropriate media type in the printer driver or in the machine's Paper Type menu setting. (See <i>About paper</i> on page 1-8 and <i>Basic tab</i> in the Software User's Guide on the CD-ROM.)</p> <p>The problem may disappear by itself. Print multiple pages to clear this problem, especially if the machine has not been used for a long time.</p> <p>The drum unit may be damaged. Put in a new drum unit. (See <i>Replacing the drum unit (DR-350)</i> on page 11-27.)</p>
 <p>Lines across the page</p>	<p>Clean the inside of the machine and the primary corona wire in the drum unit. (See <i>Cleaning the corona wire</i> on page 11-24.)</p> <p>The drum unit may be damaged. Put in a new drum unit. (See <i>Replacing the drum unit (DR-350)</i> on page 11-27.)</p>
 <p>Black lines down the page Printed pages have toner stains down the page.</p>	<p>Clean the primary corona wire of the drum unit.</p> <p>Make sure the primary corona wire blue tab is at the home position (▲).</p> <p>The drum unit may be damaged. Install a new drum unit. (See <i>Replacing the drum unit (DR-350)</i> on page 11-27.)</p> <p>The toner cartridge may be damaged. Put in a new toner cartridge. (See <i>Replacing the toner cartridge (TN-350)</i> on page 11-24.) Make sure that a torn piece of paper is not inside the machine covering the laser scanner window.</p> <p>The fixing unit may be smudged. Call Brother Customer Service at 1-800-284-4329 (in USA) or 1-877-BROTHER (in Canada).</p>
 <p>White lines down the page</p>	<p>You may clear the problem by wiping the laser scanner window with a soft cloth. (See <i>Cleaning the laser scanner window</i> on page 11-22.)</p> <p>The toner cartridge may be damaged. Put in a new toner cartridge. (See <i>Replacing the toner cartridge (TN-350)</i> on page 11-24.)</p>
 <p>Page skewed</p>	<p>Make sure the paper or other print media is loaded properly in the paper tray and that the guides are not too tight or too loose against the paper stack.</p> <p>Set the paper guides correctly.</p> <p>If you are using the manual feed slot, see <i>To load paper or other media in the manual feed slot</i> on page 1-11.</p> <p>The paper tray may be too full.</p> <p>Check the paper type and quality. (See <i>About paper</i> on page 1-8.)</p>
 <p>Curl or wave</p>	<p>Check the paper type and quality. High temperatures and high humidity will cause paper to curl.</p> <p>If you don't use the machine very often, the paper may have been in the paper tray too long. Turn over the stack of paper in the paper tray. Also, fan the paper stack and then rotate the paper 180° in the paper tray.</p>

Examples of poor print quality	Recommendation
 <p>Wrinkles or creases</p>	<p>Make sure that paper is loaded properly.</p> <p>Check the paper type and quality. (See <i>About paper</i> on page 1-8.)</p> <p>Turn over the stack of paper in the tray or rotate the paper 180° in the input tray.</p>

Compatibility

If you are having difficulty sending or receiving a fax due to possible interference on the phone line, we recommend that you adjust the Equalization for compatibility to reduce the modem speed for fax operations.

- 1 Press **Menu/Set**, **2, 0, 1**.

1. Compatibility

- 2 Press **▲** or **▼** to select **Basic** or **Normal (or High*)**.
(*FAX-2920 and MFC-7225N only)

Press **Menu/Set**.

- 3 Press **Stop/Exit**.



Note

- **Basic** reduces the modem speed to 9600 bps. Unless interference is a recurring problem on your phone line, you may prefer to use it only when needed.
- **Normal** sets the modem speed at 14400 bps.
- **High** sets the modem speed at 33600 bps (FAX-2920 and MFC 7225N only).
- When you change the Compatibility to **Basic**, the ECM feature is not available.

Packing and shipping the machine

When you transport the machine, use the packing materials that came with your machine. If you do not pack the machine properly, you could void your warranty. The machine should be adequately insured with the carrier.

- 1 Turn off the machine's power switch.
- 2 Unplug the machine from the telephone wall jack.
- 3 Unplug the machine from the AC power outlet.
- 4 Unplug all the cables from the machine.
- 5 Open the front cover.
- 6 Remove the drum unit and toner cartridge assembly. Leave the toner cartridge installed in the drum unit.
- 7 Place the drum unit and toner cartridge assembly into the plastic bag and seal the bag.
- 8 Close the front cover.
Remove the telephone line cord, ADF document output support, handset and handset curled cord.
- 9 Wrap the machine in the plastic bag and place it in the original carton with the original packing material.

- 10 Pack the drum unit and toner cartridge assembly, AC cord and printed materials in the original carton as shown below:

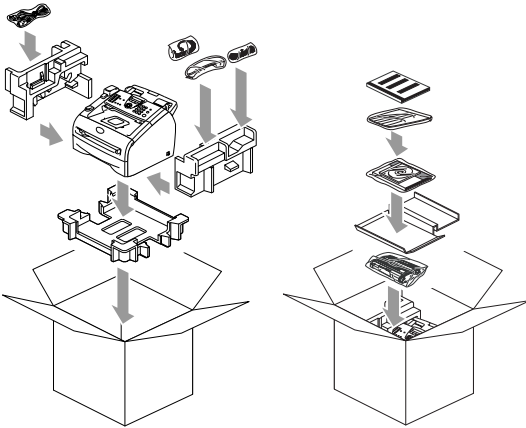

Note

If you are returning your machine to Brother as part of the Exchange Service, pack only the machine. Keep all separate parts and printed materials to use with your “Exchange” machine.

- 11 Close the carton and tape it shut.

Routine maintenance

! CAUTION

The drum unit contains toner, so handle it carefully. If toner scatters and your hands or clothes get dirty, immediately wipe or wash it off with cold water.

Cleaning the outside of the machine

! CAUTION

- Use neutral detergents. Cleaning with volatile liquids such as thinner or benzine will damage the outside surface of the machine.
- Do *not* use cleaning materials that contain ammonia.
- Do *not* use isopropyl alcohol to remove dirt from the control panel. It may crack the panel.

- 1 Pull the paper tray completely out of the machine.

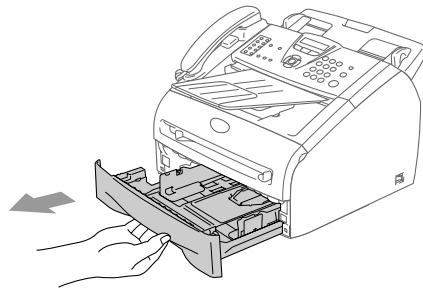

- Wipe the outside of the machine with a soft cloth to remove dust.

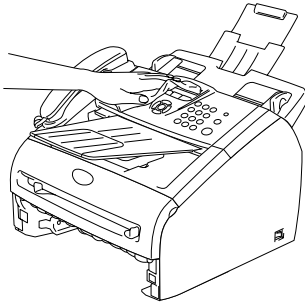

- Remove anything that is stuck inside the paper tray.

- Wipe the inside of the paper tray with a soft cloth to remove the dust.

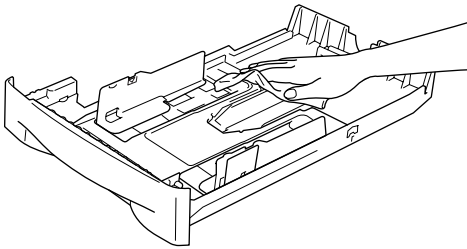

- Re-load the paper and put the paper tray in the machine.

Cleaning the scanner glass

- Turn off the machine's power switch.
- Lift the control panel cover.
- Moisten a small clean soft, lint-free cloth with isopropyl alcohol and carefully remove dirt from the glass strip and the white bar above it.

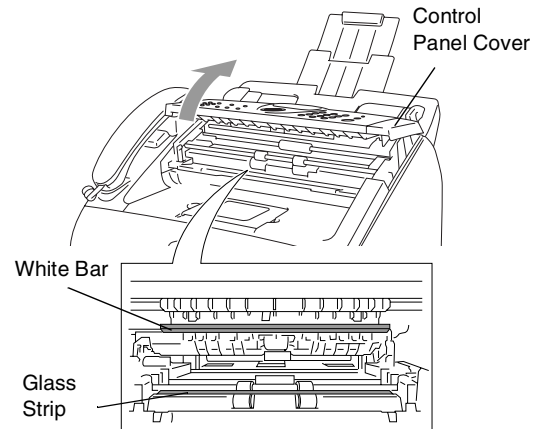

- Close the control panel cover.

Cleaning the laser scanner window

! CAUTION

- Do *not* use isopropyl alcohol to clean the laser scanner window.
- Do *not* touch the laser scanner window with your fingers.

- Before you clean the inside of the machine, turn off the machine's power switch.
Unplug the telephone line cord first, and then unplug the power cord from the AC power outlet.

- 2 Open the front cover and pull out the drum unit and toner cartridge assembly.

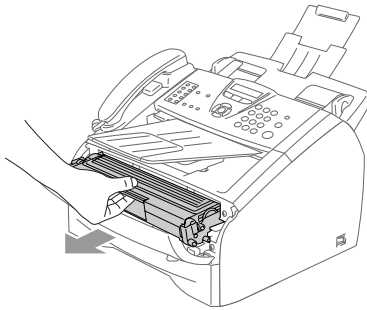

! WARNING

 Just after you have used the machine, some internal parts of the machine are extremely **HOT!** When you open the front cover of the machine, never touch the shaded parts shown in the diagram below.

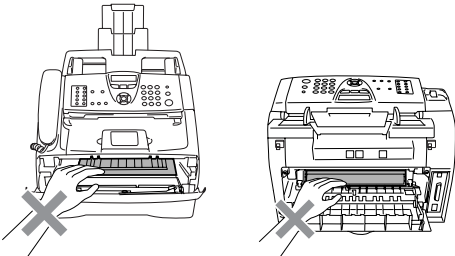

! CAUTION

To prevent damage to the machine from static electricity, do not touch the electrodes shown below.

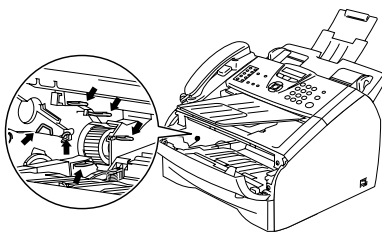

- 3 Gently clean the laser scanner window by wiping it with a clean soft, *dry* cloth. Do not use isopropyl alcohol.

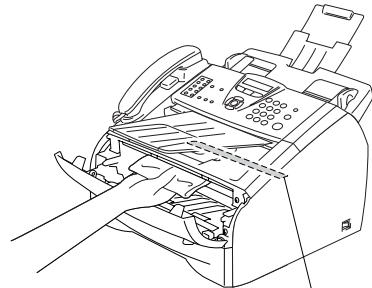

Laser Scanner Window

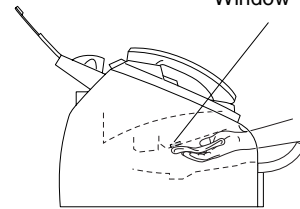

- 4 Put the drum unit and toner cartridge assembly back into the machine.

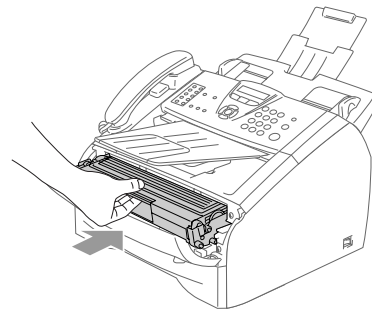

- 5 Close the front cover.
- 6 Plug the machine's power cord back into the AC power outlet first, and then plug in the telephone line cord.
Turn on the machine's power switch.

Cleaning the corona wire

We recommend placing the drum unit and toner cartridge assembly on a cloth or large disposable paper to avoid spilling and scattering toner.

- 1 Open the front cover and pull out the drum unit and toner cartridge assembly.

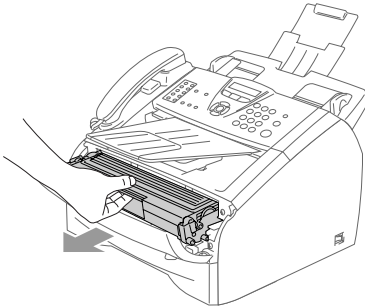

- 2 Clean the primary corona wire inside the drum unit by gently sliding the blue tab from right to left several times.

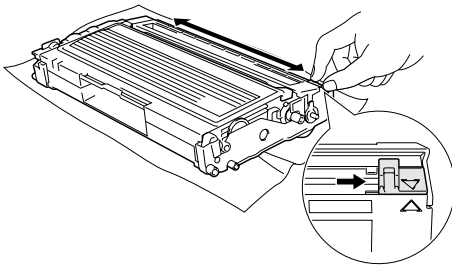

- 3 Return the blue tab and snap it into the Home position (▼).

! CAUTION

If you do not return the blue tab to the Home position (▼), your printed pages may have vertical black stripes on them.

- 4 Reinstall the drum unit and toner cartridge assembly in the machine.
- 5 Close the front cover.

Replacing the toner cartridge (TN-350)

The toner cartridge can print *up to* 2,500 pages. When the toner cartridge is running low, the LCD shows **Toner Low**. Actual page count will vary depending on your average type of document (i.e., standard letter, detailed graphics).

Note

It is a good idea to keep a new toner cartridge ready for use when you see the **Toner Low** warning.

Discard the used toner cartridge according to local regulations, keeping it separate from domestic waste. Be sure to seal the toner cartridge tightly so toner powder does not spill out of the cartridge. If you have questions, call your local waste disposal office.

We recommend that you clean the machine and drum unit when you replace the toner cartridge. (See *Cleaning the laser scanner window* on page 11-22 and *Cleaning the drum unit* on page 11-17.)

How to replace the toner cartridge

! WARNING

 Just after you use the machine, some internal parts of the machine will be extremely **HOT!** Never touch the shaded parts shown in the illustration.

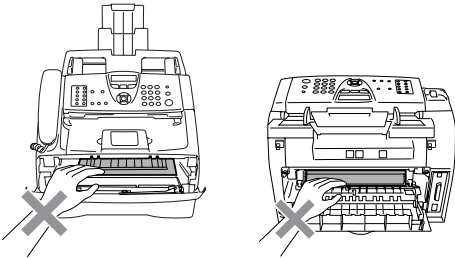

- 1 Open the front cover and pull out the drum unit and toner cartridge assembly.

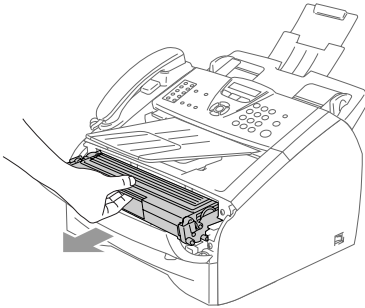

! CAUTION

To prevent damage to the machine from static electricity, do not touch the electrodes shown below.

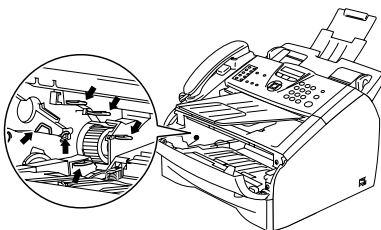

- 2 Hold down the lock lever on the left and pull the toner cartridge out of the drum unit.

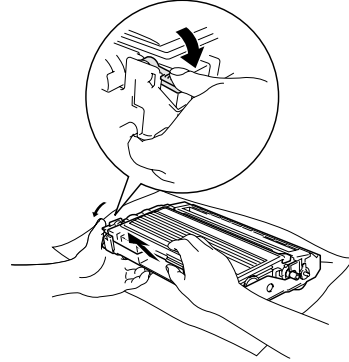

! CAUTION

- Place the drum unit on a drop cloth or large piece of disposable paper to avoid spilling and scattering the toner.
- Handle the toner cartridge carefully. If toner scatters on your hands or clothes, immediately wipe it off or wash it with cold water.

- 3 Unpack the new toner cartridge. Place the used toner cartridge into the aluminum bag and discard it according to local regulations.

! CAUTION

- Brother strongly recommends that you do not refill the toner cartridge provided with your machine. We also strongly recommend that you continue to use only Genuine Brother Brand replacement toner cartridges (**TN-350**). Using or attempting to use potentially incompatible toner and/or toner cartridges in your machine may cause damage to the machine itself and/or it may result in unsatisfactory print quality. Our warranty coverage does not apply to any problem that was caused by the use of unauthorized third party toner and toner cartridges. To protect your investment and guarantee your print quality please continue to replace consumed toner cartridges with only Genuine Brother Branded Supplies.
- Wait to unpack the toner cartridge until immediately before you install it in the machine. If a toner cartridge is left unpacked for a long period of time, the toner life is shortened.
- *Do not* touch the shaded parts shown in the illustrations to prevent any degradation to the print quality.

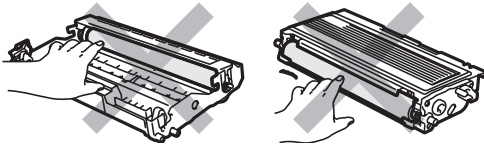

- 4 Gently rock the toner cartridge from side to side five or six times to distribute the toner evenly inside the cartridge.

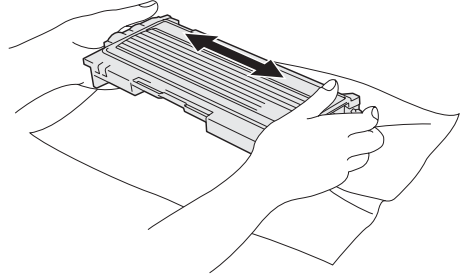

- 5 Remove the protective cover.

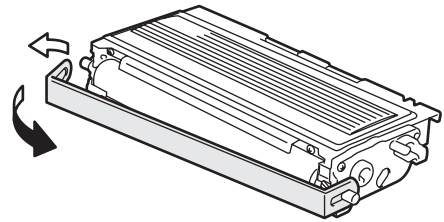

- 6 Insert the new toner cartridge in the drum unit until it clicks into place. If you put it in properly, the lock lever will lift automatically.

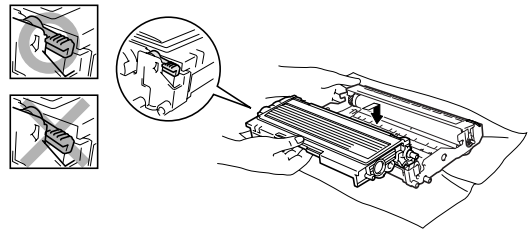

- 7 Clean the primary corona wire inside the drum unit by gently sliding the blue tab from right to left several times. Return the blue tab to the Home position (▼) before reinstalling the drum unit and toner cartridge assembly.

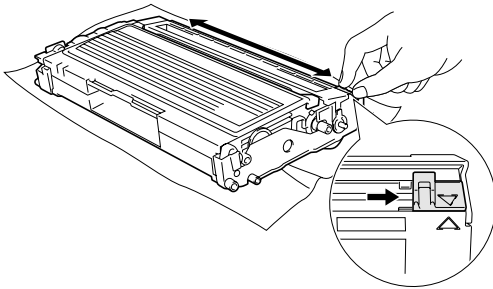

- 8 Install the drum unit and toner cartridge assembly in the machine.
- 9 Close the front cover.

Replacing the drum unit (DR-350)

The machine uses a drum unit to create print images on paper. If the LCD shows *Change Drum Soon*, the drum unit is near the end of its life and it is time to buy a new one.

Even if the LCD shows *Change Drum Soon*, you may be able to continue printing without having to replace the drum unit for a while. However, if there is a noticeable deterioration in the output print quality (even before *Change Drum Soon* appears), then the drum unit should be replaced. You should clean the machine when you replace the drum unit. (See *Cleaning the laser scanner window* on page 11-22.)

! CAUTION

When removing the drum unit, handle it carefully because it contains toner. If toner scatters and your hands or clothes get dirty, immediately wipe or wash it off with cold water.

✎ Note

The drum unit is a consumable item, and it is necessary to replace it periodically. There are many factors that determine the actual drum life, such as temperature, humidity, type of paper and how much toner you use for the number of pages per print job. The estimated drum life is *up to* 12,000 pages. The actual number of pages your drum will print may be significantly less than these estimates. Because we have no control over the many factors that determine the actual drum life, we cannot guarantee a minimum number of pages that will be printed by your drum.

! WARNING

 Just after you have used the machine, some internal parts of the machine are extremely **HOT!** So please be careful.

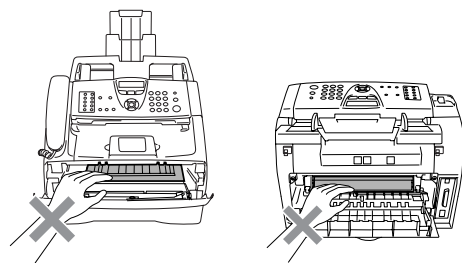

- 1 Open the front cover and pull out the drum unit and toner cartridge assembly.

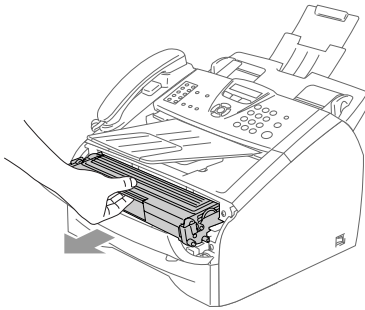

! CAUTION

To prevent damage to the printer from static electricity, do not touch the electrodes shown below.

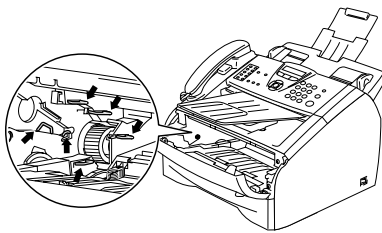

- 2 Hold down the lock lever on the left and pull the toner cartridge out of the drum unit.

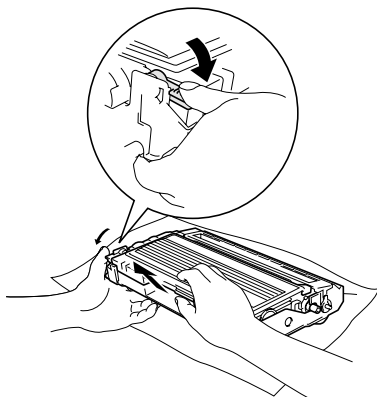

Note

Discard the used drum unit according to local regulations, keeping it separate from domestic waste. Be sure to seal the drum unit tightly so toner powder does not spill out of the unit. If you have questions, call your local waste disposal office.

! CAUTION

Wait to unpack the new drum unit until immediately before installing it. Place the old drum unit into the plastic bag.

- 3 Unpack the new drum unit.
- 4 Reinstall the toner cartridge into the new drum unit. If you put it in properly, the lock lever will lift automatically.

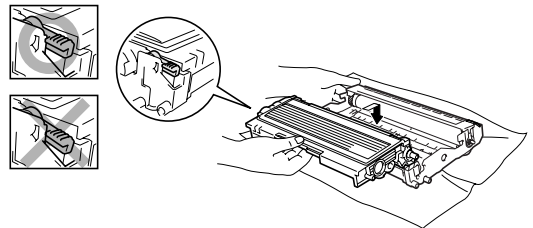

- 5 Install the drum unit and toner cartridge assembly in the machine.

- 6 Press **Options**.

Replace Drum?

1.Yes 2.No

To confirm you are installing a new drum, press 1.

- 7 When the LCD shows *Accepted*, close the front cover.

! CAUTION

If toner scatters and your hands or clothes get dirty, immediately wipe off or wash with cold water.

Machine Information

Checking the Serial Numbers

You can view the machine's serial number on the LCD.

- 1 For FAX-2820, FAX-2920 and MFC-7220, press **Menu/Set, 4, 1**.

—OR—

For MFC-7225N, press **Menu/Set, 6, 1**.

1.Serial No.

- 2 Press **Stop/Exit**.

Checking the Page Counters

You can view the machine's page counters for copies, printer pages, reports and lists, faxes or a summary total.

- 1 For FAX-2820, FAX-2920 and MFC-7220, press **Menu/Set, 4, 2**.

—OR—

For MFC-7225N, press **Menu/Set, 6, 2**.

2.Page Counter

- 2 Press **▲** or **▼** to select **Total**, **Copy**, **Print** or **List/Fax**.

Total :XXXXXX

Copy :XXXXXX

Print :XXXXXX

List/Fax :XXXXXX

- 3 Press **Stop/Exit**.

Checking the Drum Life

You can view the machine's drum life on the LCD.

- 1 For FAX-2820, FAX-2920 and MFC-7220, press **Menu/Set, 4, 3**.

—OR—

For MFC-7225N, press **Menu/Set, 6, 3**.

3.Drum Life

Remaining:XXX%

- 2 Press **Stop/Exit**.



Note

The drum life check will be accurate only if you have reset the drum counter when you installed a *new* drum unit. It will not be accurate if you have reset the drum counter during the life of a *used* drum.

Setting up telephone services

Your machine supports the Distinctive Ring and Caller ID subscriber telephone services that some telephone companies offer.



Note

- If you have Voice Mail, Call Waiting, Call Waiting/Caller ID, RingMaster, an answering service, an alarm system or other custom features on your telephone line, it may affect the way your machine works. (See *Custom features* on page 1-12 and *Custom features on a single line* on page 11-12.)
- If you have Voice Mail on your phone line, please read the following carefully.

Distinctive Ring

Brother uses the term 'Distinctive Ring' but different telephone companies have other names for this service such as SmartRing, RingMaster, Teen-Ring, Indent-a-Call or Indent-a-Ring.

What does your telephone company's 'Distinctive Ring' do?

Your telephone company's Distinctive Ring service allows you to have more than one number on the same phone line. **If you need more than one phone number, it is cheaper than paying for an extra line.** Each phone number has its own distinctive ring pattern, so you will know which phone number is ringing. This is one way you can have a separate phone number for your machine.



Note

Please call your telephone company for availability and rates.

What does Brother's 'Distinctive Ring' do?

The Brother machine has a Distinctive Ring feature that allows you to use your machine to take full advantage of the telephone company's Distinctive Ring service. The new phone number on your line can just receive faxes.



Note

You must pay for your telephone company's Distinctive Ring service before you program the machine to work with it.

Do you have Voice Mail?

If you have Voice Mail on the phone line that you will install your new machine on, *there is a strong possibility that Voice Mail and the machine will conflict with each other while receiving incoming calls.* **However, the Distinctive Ring feature allows you to use more than one number on your line, so both Voice Mail and the machine can work together without any problems.** If each one has a separate phone number, neither will interfere with the other's operations.

If you decide to get the Distinctive Ring service from the telephone company, you will need to follow the directions on next page to 'register' the new Distinctive Ring pattern they give you. This is so your machine can recognize its incoming calls.







Note

You can change or cancel the Distinctive Ring pattern at any time. You can switch it off temporarily, and turn it back on later. When you get a new fax number, make sure you reset this feature.

Before you choose the ring pattern to register

You can only register one Distinctive Ring pattern with the machine. Some ring patterns cannot be registered. The ring patterns below are supported by your Brother machine. Register the one your telephone company gives you.

Ring Pattern	Rings	
1	long-long	
2	short-long-short	
3	short-short-long	
4	very long (normal pattern)	



Note

If the ring pattern you received is not on this chart, **please call your telephone company and ask for one that is shown.**

- The machine will only answer calls to its registered number.
- The first two rings are silent on the machine. This is because the fax must «listen» to the ring pattern (to compare it to the pattern that was 'registered'). (Other telephones on the same line will ring.)
- If you program the machine properly, it will recognize the registered ring pattern of the 'fax number' within 2 ring patterns and then answer with a fax tone. When the 'voice number' is called, the machine will not answer.

Registering the Distinctive Ring pattern

Very important!

After you have set the Distinctive Ring feature to ON, the receive mode is set to **Manual** automatically. Unless you have a TAD or Voice Mail set up on the Distinctive Ring number, **Manual** mode means you must answer all the calls yourself. You can not change the receive mode to another mode while the Distinctive Ring is set to on.

- 1 Press **Menu/Set**, **2**, **0**, **2**.

2.Distinctive

- 2 Press **▲** or **▼** to select **Set**.
Press **Menu/Set**.

- 3 Press **▲** or **▼** to select the stored ring pattern you want to use.
Press **Menu/Set**.

(You will hear each pattern as you scroll through the four patterns. Make sure you choose the pattern that the telephone company gave you.)

- 4 Press **Stop/Exit**. Distinctive Ring is now set to on.

Turning off the Distinctive Ring

- 1 Press **Menu/Set**, **2**, **0**, **2**.

2.Distinctive

- 2 Press **▲** or **▼** to select **Off**.
Press **Menu/Set**.

- 3 Press **Stop/Exit**.

**Note**

If you turn off Distinctive Ring, the machine will stay in `Manual` receive mode. You will need to set the Receive Mode again. (See *To select or change your Receive Mode* on page 4-2.)

Caller ID

**Note**

The Caller ID feature lets you use the Caller ID subscriber service offered by many local telephone companies. This service displays the telephone number, or name if it is available, of your caller as the line rings.

After a few rings, the LCD shows the telephone number of your caller (and name, if available). Once you pick up the handset, the Caller ID information disappears from the LCD, but the call information remains stored in the Caller ID memory.

- You will see the first 16 characters of the number (or name).
- `Out of Area` display means call originated outside your Caller ID service area.
- `Private Call` display means the caller has intentionally blocked transmission of information.

You can print a list of Caller ID information received by your machine. (See *Printing Caller ID List* on page A-3.)

Caller ID service varies with different carriers. Call your local telephone company to determine the kind of service available in your area.

Viewing Caller ID List

Caller ID memory stores information for up to thirty calls. When the thirty-first call comes in, information about the first call is erased. You can scroll through Caller ID information to review those calls made to your machine.

- 1 Press **Menu/Set**, **2**, **0**, **3**.

3.Caller ID

- 2 Press **▲** or **▼** to select `Display#`.

Press **Menu/Set**.

The caller ID of the last call will appear on the display. If no ID is stored, the beeper will sound and `No Caller ID` will appear on the display.

- 3 Press **▲** or **▼** to scroll through the Caller ID memory to select the Caller ID you want to view, and then press **Menu/Set**. The LCD shows the caller's number and the date and time of the call.

- 4 Press **◀** to return to the Caller ID listing.

—OR—

Press **Stop/Exit**.

Printing Caller ID List

- 1 Press **Menu/Set**, **2**, **0**, **3**.

3.Caller ID

- 2 Press **▲** or **▼** to select `Print Report`.

Press **Menu/Set**.

If no ID is stored, the beeper will sound and `No Caller ID` will appear on the display.

- 3 Press **Start**.

- 4 After printing has finished, press **Stop/Exit**.

Call Waiting

The Call Waiting feature lets you use the Call Waiting subscriber service offered by many local telephone companies. This feature enables you to take a second call on your machine, without disconnecting the first caller.

- 1 To answer a Call Waiting signal while you are talking on the phone, ask the other party if you can put them on Hold to catch the other call.
- 2 Press **Search/Speed Dial** to switch to the second call.
- 3 To switch back to the first call, press **Search/Speed Dial** again.



Note

Either caller can hang up at any time. However, if you hang up you will disconnect both callers.

Advanced receiving operations

Operation from extension telephones

If you answer a fax call on an extension telephone or an external telephone connected to the EXT. jack of the machine, you can make your machine take the call by using the Fax Receive Code. When you press the Fax Receive Code *51, the machine starts to receive the fax. (See *Easy Receive* on page 4-3.)

If the machine answers a voice call and double-rings for you to take over, use the Telephone Answer Code #51 to take the call at an extension phone. (See *Setting the F/T Ring Time (Fax/Tel mode only)* on page 4-3.)

If you answer a call and no one is on the line, you should assume that you're receiving a manual fax.

- Press *51 and wait for the chirp or until the machine's LCD displays *Receiving*, and then hang up.

For Fax/Tel mode only

When the machine is in Fax/Tel mode, it will use the F/T Ring Time (pseudo/double-ringing) to alert you to pick up a voice call.

If you're at the machine, you can lift the handset to answer.

If you're at an extension phone, you'll need to lift the handset during the F/T Ring Time and then press #51 between the pseudo/double rings. If no one is on the line, or if someone wants to send you a fax, send the call back to the machine by pressing *51.

Using a cordless external handset

If your cordless telephone is connected to the EXT. jack on the machine and you typically carry the cordless handset elsewhere, it is easier to answer calls during the Ring Delay.

Changing the remote codes

The preset Fax Receive Code is *51. The preset Telephone Answer Code is #51. If you want to, you can replace them with your own codes.

- 1 If it is not illuminated in green, press  (Fax).
- 2 Press **Menu/Set**, **2**, **1**, **4**.
- 3 Press **▲** or **▼** to select **On** (or **Off**). Press **Menu/Set**.
- 4 Enter the new Fax Receive Code. Press **Menu/Set**.
- 5 Enter the new Telephone Answer Code. Press **Menu/Set**.
- 6 Press **Stop/Exit**.



Note

- If you are always disconnected when accessing your external TAD remotely, try changing the Fax Receive Code and Telephone Answer Code to another three-digit code (such as ### and 999)
- Remote Codes might not work with some telephone systems.

Connecting an external device to your machine

Connecting an external telephone

You can connect a separate telephone (or telephone answering device) directly to your machine as shown in the diagram below.

Connect the telephone line cord to the jack labeled EXT. in the left of the machine.

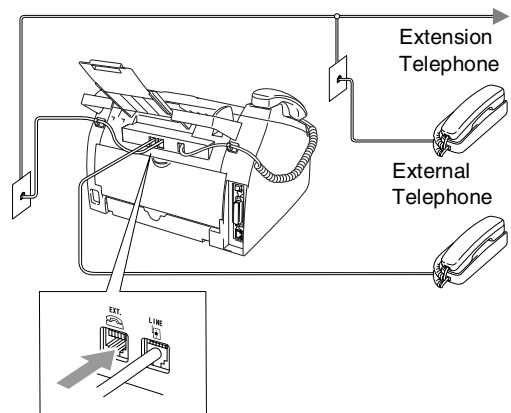

When you are using an external phone, the LCD shows **Ext. Tel in Use**.

Connecting an external telephone answering device (TAD)

Sequence

You may choose to connect an external answering device. However, when you have an **external** TAD on the same telephone line as the machine, the TAD answers all calls and the machine “listens” for fax calling (CNG) tones. If it hears them, the machine takes over the call and receives the fax. If it does not hear CNG tones, the machine lets the TAD continue playing your outgoing message so your caller can leave you a voice message.

The TAD must answer within four rings (the recommended setting is two rings). The machine cannot hear CNG tones until the TAD has answered the call, and with four rings there are only 8 to 10 seconds of CNG tones left for the fax “handshake”. Make sure you carefully follow the instructions in this guide for recording your outgoing message. We do not recommend using the toll saver feature on your external answering machine if it exceeds five rings.

Note

- If you do not receive all your faxes, reduce the Ring Delay setting on your external TAD.
- *If You Subscribe to your Telephone Company's Distinctive Ring Service:* You may connect an external TAD to a separate wall jack only if you subscribe to your telephone company's Distinctive Ring service, have registered the distinctive ring pattern on your machine, and use that number as a fax number. The recommended setting is at least four rings on the external TAD when you have the telephone company's Distinctive Ring Service. You cannot use the Toll Saver setting.
- *If You Do Not Subscribe to Distinctive Ring Service:* You must plug your TAD into the EXT. jack of your machine. If your TAD is plugged into a wall jack, both your machine and the TAD will try to control the phone line. (See illustration below.)

Improper Setup

Unless you are using Distinctive Ring, do not connect a TAD elsewhere on the same phone line.

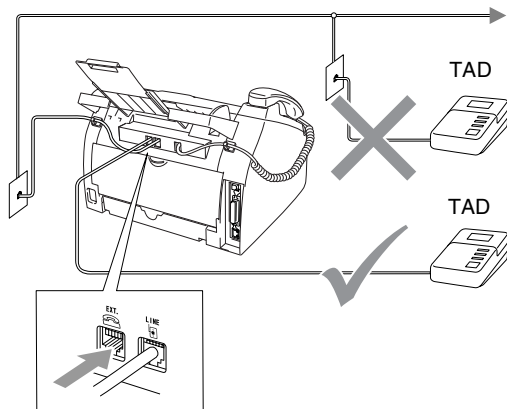

When the TAD answers a call, the LCD shows `Ext. Tel in Use`.

Connections

The external TAD must be plugged into the back of the machine, into the jack labeled EXT. Your machine cannot work properly if you plug the TAD into a wall jack (unless you are using Distinctive Ring).

- 1 Plug the telephone line cord from the telephone wall jack into the back of the machine, in the jack labeled LINE.
- 2 Plug the telephone line cord from your external TAD into the back of the machine, in the jack labeled EXT. (Make sure this cord is connected to the TAD at the TAD's telephone *line* jack, and not its handset jack.)
- 3 Set your external TAD to four rings or less. (The machine's Ring Delay setting does not apply.)
- 4 Record the outgoing message on your external TAD.
- 5 Set the TAD to answer calls.

- 6 Set the Receive Mode to External TAD.
(See *Choosing the Receive Mode* on page 4-1.)

Recording outgoing message (OGM) on an external TAD

Timing is important in recording this message.

- 1 Record 5 seconds of silence at the beginning of your message. (This allows your machine time to listen for the fax CNG tones of automatic transmissions before they stop.)
- 2 Limit your speaking to 20 seconds.
- 3 End your 20-second message by giving your Fax Receive Code for people sending manual faxes. For example: *“After the beep, leave a message or send a fax by pressing * 51 and Start.”*



Note

We recommend beginning your OGM with an initial 5-second silence because the machine cannot hear fax tones over a resonant or loud voice. You may try omitting this pause, but if your machine has trouble receiving, then you must re-record the OGM to include it.

Special line considerations

Roll over phone lines

A roll over phone system is a group of two or more separate telephone lines that pass incoming calls to each other if they are busy. The calls are usually passed down or “rolled over” to the next available phone line in a preset order.

Your machine can work in a roll over system as long as it is the last number in the sequence, so the call cannot roll away. Do not put the machine on any of the other numbers; when the other lines are busy and a second fax call is received, the fax call would be transferred to a line that does not have a fax machine. **Your machine will work best on a dedicated line.**

Two-line phone system

A two-line phone system is nothing more than two separate phone numbers on the same wall outlet. The two phone numbers can be on separate jacks (RJ11) or combined into one jack (RJ14). Your machine must be plugged into an RJ11 jack. RJ11 and RJ14 jacks may be equal in size and appearance and both may contain four wires (black, red, green, yellow). To test the type of jack, plug in a two-line phone and see if it can access both lines. If it can, you must separate the line for your machine. (See *Easy Receive* on page 4-3.)

Converting telephone wall outlets

There are three ways to convert to an RJ11 jack. The first two ways may require assistance from the telephone company. You can change the wall outlets from one RJ14 jack to two RJ11 jacks. Or, you can have an RJ11 wall outlet installed and slave or jump one of the phone numbers to it.

The third way is the easiest: Buy a triplex adapter. You can plug a triplex adapter into an RJ14 outlet. It separates the wires into two separate RJ11 jacks (Line 1, Line 2) and a third RJ14 jack (Lines 1 and 2). If your machine is on Line 1, plug the machine into L1 of the triplex adapter. If your machine is on Line 2, plug it into L2 of the triplex adapter.

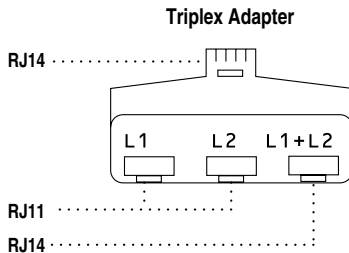

Installing machine, external two-line TAD and two-line telephone

When you are installing an external two-line telephone answering device (TAD) and a two-line telephone, your machine must be isolated on one line at both the wall jack and at the TAD. The most common connection is to put the machine on Line 2, which is explained in the following steps. The back of the two-line TAD must have two telephone jacks: one labeled L1 or L1/L2, and the other labeled L2. You will need at least three telephone line cords, the one that came with your machine and two for your external two-line TAD. You will need a fourth line cord if you add a two-line telephone.

- 1 Place the two-line TAD and the two-line telephone next to your machine.
- 2 Plug one end of the telephone line cord for your machine into the L2 jack of the triplex adapter. Plug the other end into the LINE jack on the back of the machine.
- 3 Plug one end of the first telephone line cord for your TAD into the L1 jack of the triplex adapter. Plug the other end into the L1 or L1/L2 jack of the two-line TAD.
- 4 Plug one end of the second telephone line cord for your TAD into the L2 jack of the two-line TAD. Plug the other end into the EXT. jack on the left side of the machine.

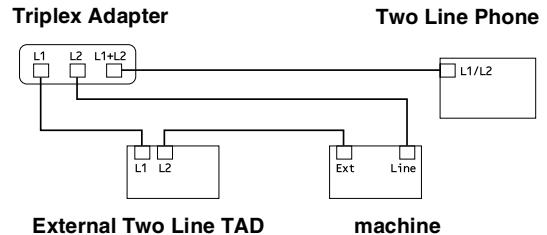

You can keep two-line telephones on other wall outlets as always. There are two ways to add a two-line telephone to the machine's wall outlet. You can plug the telephone line cord from the two-line telephone into the L1+L2 jack of the triplex adapter. Or, you can plug the two-line telephone into the TEL jack of the two-line TAD.

Multi-line connections (PBX)

Most offices use a central telephone system. While it is often relatively simple to connect the machine to a key system or a PBX (Private Branch Exchange), we suggest that you contact the company that installed your telephone system and ask them to connect the machine for you. It is advisable to have a separate line for the machine.

If the machine is to be connected to a multi-line system, ask your installer to connect the unit to the last line on the system. This prevents the unit from being activated each time a telephone call is received.

If you are installing the machine to work with a PBX

- 1 It is not guaranteed that the unit will operate properly under all circumstances with a PBX. Any cases of difficulty should be reported first to the company that handles your PBX.
- 2 If all incoming calls will be answered by a switchboard operator, it is recommended that the Receive Mode be set to *Manual*. All incoming calls should initially be regarded as telephone calls.

Custom features on your phone line

If you have Voice Mail, Call Waiting, Call Waiting/Caller ID, RingMaster, an answering service, an alarm system or other custom feature on one phone line it may create a problem with the operation of your machine. (See *Custom features on a single line*. on page 11-12.)

On-screen programming

Your machine is designed to be easy to use with LCD on-screen programming using the navigation keys. User-friendly programming helps you take full advantage of all the menu selections your machine has to offer.

Since your programming is done on the LCD, we have created step-by-step on-screen instructions to help you program your machine. All you need to do is follow the instructions as they guide you through the menu selections and programming options.

Menu table

The Menu table that begins on page B-3 will help you understand the menu selections and options that are found in the machine's programs. Once you become familiar with programming, you can use the Menu table as a quick reference when you want to change your settings.



Note

You can program your machine by pressing **Menu/Set**, followed by the menu numbers. For example to set Beeper Volume to **LOW**. Press **Menu/Set**, **1**, **4**, **2** and **▲** or **▼** to select **LOW**. Press **Menu/Set**.

Memory storage





If there is a power failure, you will not lose your menu settings because they are stored permanently. Temporary settings (such as Contrast, Overseas Mode, and so on) will be lost. You may also have to reset the date and time.

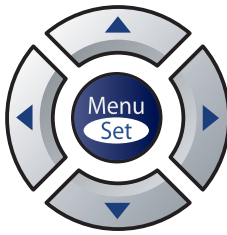

Note

Your machine can store the date and time up to 2 hours (FAX-2820 and MFC-7220) or up to 4 days (FAX-2920 and MFC-7225N).

Navigation keys

	
	Access the menu Go to the next menu level Accept an option
	Scroll through the current menu level
	Go back to the previous menu level or forward to the next menu level
	Exit the menu

You can access the menu mode by pressing **Menu/Set**.

When you enter the menu, the LCD scrolls.

Press **1** for General Setup menu

1.General Setup

—OR—

Press **2** for Fax menu

2.Fax

—OR—

Press **3** for Copy menu

3.Copy

⋮

Press **0** for Initial Setup

0.Initial Setup

You can scroll more quickly through each menu level by pressing the arrow for the direction you want: ▲ or ▼.

Select an option by pressing **Menu/Set** when that option appears on the LCD.

The LCD will then show the next menu level.

Press ▲ or ▼ to scroll to your next menu selection.

Press **Menu/Set**.

When you finish setting an option, the LCD shows *Accepted*.

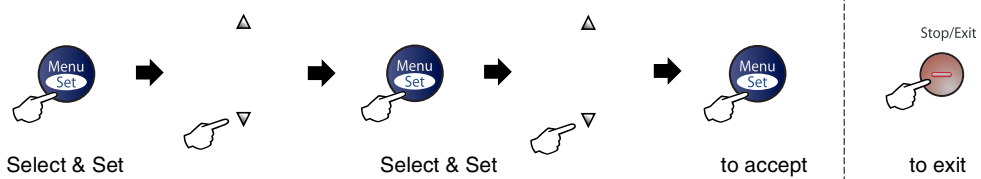

Main Menu	Submenu	Menu Selections	Options	Descriptions	Page	
1. General Setup	1. Mode Timer (FAX-2820 and FAX-2920 only)	—	5 Mins 2 Mins 1 Min 30 Secs 0 Sec Off	Sets the time to return to Fax mode.	2-3	
	1. Mode Timer (MFC-7220 and MFC-7225N only)	—	5 Mins 2 Mins 1 Min 30 Secs 0 Sec Off	Sets the time to return to Fax mode.	2-3	
	2. Paper Type	—	Thin Plain Thick Thicker Transprncy Recycled	Sets the type of paper in the paper tray.	2-4	
	3. Paper Size	—	A4 Letter Legal Executive A5 A6 B5 B6	Sets the size of the paper in the paper tray.	2-4	
	4. Volume	1. Ring	—	High Med Low Off	Adjusts the ring volume.	2-5
		2. Beeper	—	High Med Low Off	Adjusts the volume level of the beeper.	2-5
		3. Speaker	—	High Med Low Off	Adjusts the speaker volume.	2-5

Note

The factory settings are shown in Bold.

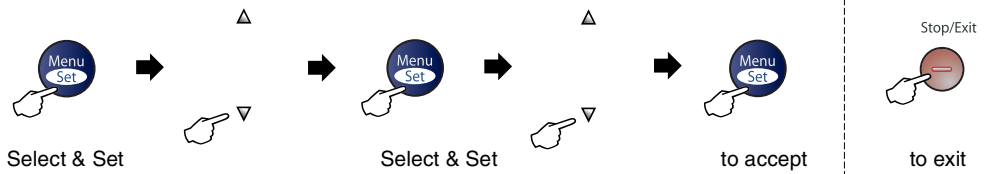

Main Menu	Submenu	Menu Selections	Options	Descriptions	Page	
1. General Setup (Continued)	4. Volume (Continued)	4. Handset	High Low	Adjusts the handset volume.	2-6	
		5. Volume Amplify	On (Permanent/ Temporary) Off	For the hearing-impaired, you can set the volume to the Vol Amplify:On setting on a permanent or temporary basis.	2-6 2-7	
	5. Auto Daylight	—	On Off	Changes for Daylight Savings Time automatically.	2-7	
	6. Ecology	1. Toner Save	On Off	Increases the life of the toner cartridge.	2-7	
		2. Sleep Time	(0-99) 05 Min	Conserves power.	2-8	
	7. LCD Contrast	—	Light Dark	Adjust the contrast of the LCD.	2-8	
	8. Security	1. TX Lock (FAX-2820 and MFC-7220 only)			Prohibits most operations except receiving faxes.	2-9
		1. Mem Security (FAX-2920 and MFC-7225N only)			Prohibits most operations except receiving faxes into the memory.	2-10
		2. Setting Lock			Prohibits the settings for Date & Time, Station ID, Quick-Dial and General Setup.	2-12



Note

The factory settings are shown in Bold.

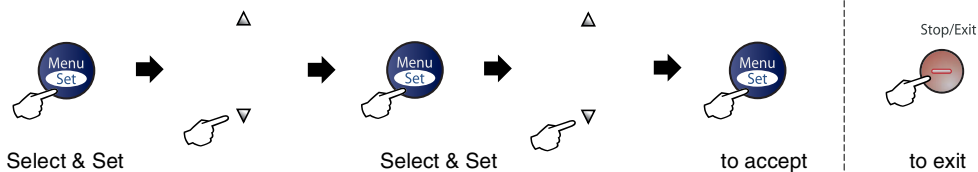

Main Menu	Submenu	Menu Selections	Options	Descriptions	Page
2. Fax	1. Setup Receive (In Fax mode only)	1. Ring Delay	04 03 02 01 00	Sets the number of rings before the machine answers in Fax Only or Fax/Tel mode.	4-2
		2. F/T Ring Time	70 Sec 40 Sec 30 Sec 20 Sec	Sets the pseudo/double-ring time in Fax/Tel mode.	4-3
		3. Easy Receive	On Semi Off	Receives fax messages without pressing Start .	4-3
		4. Remote Code	On (*51, #51) Off	You can answer all calls at an extension or external phone and use codes to turn the machine on or off. You can personalize these codes.	A-5
		5. Auto Reduction	On Off	Reduces the size of incoming faxes.	4-4
		6. Print Density	▼ -□□□□■+ ▲ ▼ -□□□■□+ ▲ ▼ -□□■□□+ ▲ ▼ -□■□□□+ ▲ ▼ -■□□□□+ ▲	Makes printouts darker or lighter.	4-5
		7. Polling RX	—	Sets up your machine to poll another fax machine.	4-5

Note

The factory settings are shown in Bold.

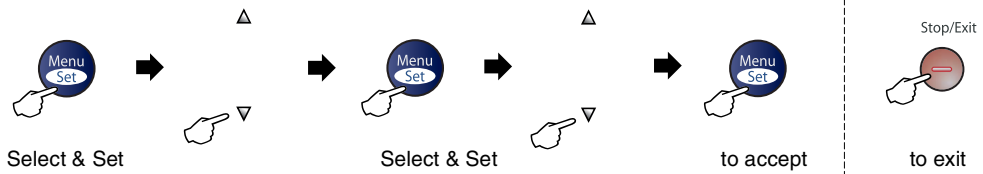

Main Menu	Submenu	Menu Selections	Options	Descriptions	Page
2. Fax (Continued)	2. Setup Send (In Fax mode only)	1. Contrast	Auto Light Dark	Changes the lightness or darkness of faxes you send.	3-5
		2. Fax Resolution	Standard Fine S.Fine Photo	Sets the default resolution for outgoing faxes.	3-5
		3. Delayed Fax	—	Sets the time of day in 24 hour format that the delayed faxes will be sent.	3-11
		4. Batch TX	On Off	Combines delayed faxes to the same fax number at the same time of day into one transmission.	3-11
		5. Real Time TX	Off On Next Fax:On Next Fax:Off	You can send a fax without using the memory.	3-6
		6. Polled TX	On Off	Sets up your machine with an document to be retrieved by another fax machine.	3-12
		7. Coverpg Setup	Off On Next Fax:On Next Fax:Off Print Sample	Automatically sends a Cover Page you have programmed.	3-10
		8. Coverpage Msg	—	You can set up your own comments for fax Cover Page.	3-9
		9. Overseas Mode	On Off	If you are having difficulty sending faxes overseas, set this to On.	3-10



Note

The factory settings are shown in Bold.

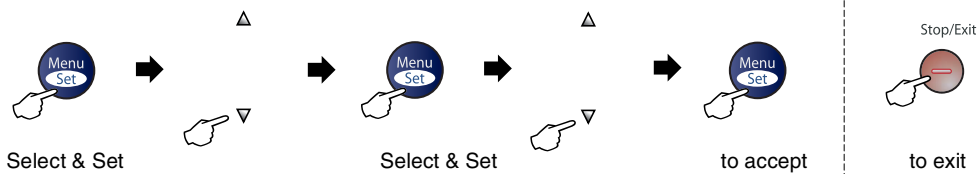

Main Menu	Submenu	Menu Selections	Options	Descriptions	Page
2. Fax (Continued)	3. Set Quick-Dial	1. One-Touch Dial		Stores One-Touch Dial numbers, so you can dial by pressing one key (and Start).	5-1
		2. Speed-Dial	—	Stores Speed-Dial numbers, so you can dial by pressing only a few keys (and Start).	5-2
		3. Setup Groups	—	Sets up a Group number for Broadcasting.	5-3
	4. Report Setting	1. Transmission	On On+Image Off Off+Image	Initial setup for Transmission Verification Report and Fax Journal.	7-1
		2. Journal Period	Every 7 Days Every 2 Days Every 24 Hours Every 12 Hours Every 6 Hours Every 50 Faxes Off		7-2
	5. Remote Fax Opt	1. Fwd/Page/Store	Off Fax Forward Paging Fax Storage PC Fax Receive* *MFC-7220 and MFC-7225N only (Backup Print)	Sets the machine to forward fax messages, to call your pager or to store incoming faxes in the memory (so you can retrieve them while you are away from your machine). The PC Fax Receive option on MFC models allow you to send faxes to your PC. If you selected Fax Forward or PC Fax Receive, you can turn on the safety feature Backup Print.	6-1
					6-2
		6-3			
	2. Remote Access	---*	You must set your own code for Remote Retrieval.	6-5	
3. Print Fax	—	Prints incoming faxes stored in the memory.	4-5		



Note

The factory settings are shown in Bold.

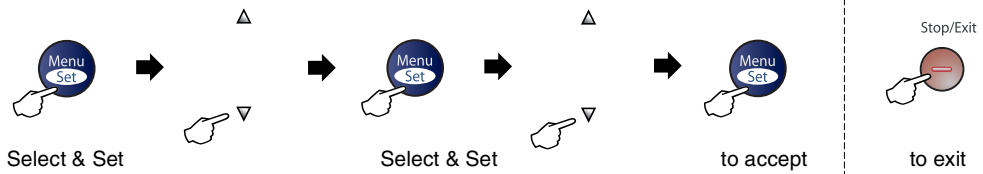

Main Menu	Submenu	Menu Selections	Options	Descriptions	Page
2. Fax (Continued)	6. Remaining Jobs	—	—	Checks which jobs are in the memory and lets you cancel selected jobs.	3-8
	0. Miscellaneous	1. Compatibility (For FAX-2820 and MFC-7220)	Normal Basic	Adjusts the equalization for transmission problems.	11-20
		1. Compatibility (For FAX-2920 and MFC-7225N)	High Normal Basic	Adjusts the equalization for transmission problems.	11-20
		2. Distinctive	Off Set (On)	Uses the Telephone Company's Distinctive Ring subscriber service to register the ring pattern with the machine.	A-1
		3. Caller ID	Display# Print Report	View or print a list of the last 30 Caller IDs stored in the memory.	A-3
3. Copy	1. Quality	—	Text Auto Photo	Selects the Copy resolution for your type of document.	8-7
	2. Contrast	—	▼-□□□□■+ ▲ ▼-□□□■□+ ▲ ▼-□□■□□+ ▲ ▼-□■□□□+ ▲ ▼-■□□□□+ ▲	Adjusts the contrast for copies.	8-7
4. Printer (MFC-7225N only)	1. Emulation	—	Auto HP LaserJet BR-Script 3	Selects the emulation mode.	See Software User's Guide on the CD-ROM
	2. Print Options	1. Internal Font	—	Prints a list of the machine's internal fonts.	
		2. Configuration	—	Prints a list of the machine's printer settings.	
3. Reset Printer	—	—	—	Returns the PCL setting to the original factory default settings.	



Note

The factory settings are shown in **Bold**.

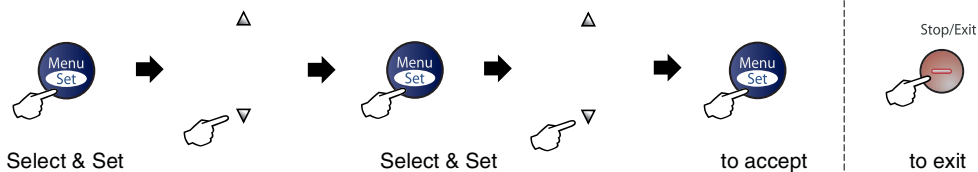

Main Menu	Submenu	Menu Selections	Options	Descriptions	Page
5. LAN (MFC-7225N only)	1. Setup TCP/IP	1. BOOT Method	Auto Static RARP BOOTP DHCP	You can choose the BOOT method that best suits your needs.	See Network User's Guide on the CD-ROM
		2. IP Address	[000-255]. [000-255]. [000-255]. [000-255]	Enter the IP address.	
		3. Subnet Mask	[000-255]. [000-255]. [000-255]. [000-255]	Enter the Subnet mask.	
		4. Gateway	[000-255]. [000-255]. [000-255]. [000-255]	Enter the Gateway address.	
		5. Node Name	BRN_XXXXXX	Enter the Node name.	
		6. WINS Config	Auto Static	You can choose the WINS configuration mode.	
		7. WINS Server	(Primary) 000.000.000.000 (Secondary) 000.000.000.000	Specifies the IP address of the primary or secondary WINS server.	
		8. DNS Server	(Primary) 000.000.000.000 (Secondary) 000.000.000.000	Specifies the IP address of the primary or secondary DNS server.	
		9. APIPA	On Off	Automatically allocates the IP address from the link-local address range.	
	2. Setup Misc.	1. Ethernet	Auto 100B-FD 100B-HD 10B-FD 10B-HD	Selects Ethernet link mode.	
	0. Factory Reset	—	—	Restore all network settings to factory default.	



Note

The factory settings are shown in Bold.

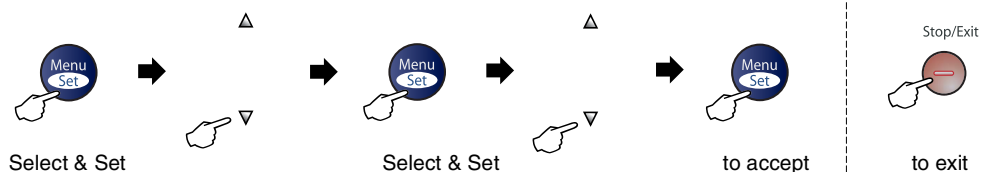

Main Menu	Submenu	Menu Selections	Options	Descriptions	Page
4. Machine Info. (FAX-2820, FAX-2920 and MFC-7220)	1. Serial No.	—	—	Lets you check the serial number of your machine.	11-29
	2. Page Counter	—	Total Copy Print List/Fax	Lets you check the number of total pages the machine has printed during its life.	11-29
	3. Drum Life	—	—	You can check the percentage of drum life that remains available.	11-29
6. Machine Info. (MFC-7225N)	1. Serial No.	—	—	Lets you check the serial number of your machine.	11-29
	2. Page Counter	—	Total Copy Print List/Fax	Lets you check the number of total pages the machine has printed during its life.	11-29
	3. Drum Life	—	—	You can check the percentage of drum life that remains available.	11-29
0. Initial Setup	1. Receive Mode	—	Fax Only Fax/Tel External TAD Manual	You can choose the receive mode that best suits your needs.	4-1
	2. Date/Time	—	—	Puts the date and time on the LCD and in headings of faxes you send.	2-1
	3. Station ID	—	Fax: Tel: Name:	Program your name and fax number to appear on each page you fax.	2-2
	4. Tone/Pulse (Canada only)	—	Tone Pulse	Selects the dialing mode.	2-1
	0. Local Language (Canada only)	—	English French	Allows you to change the LCD language for your country.	See Quick Setup Guide

Note

The factory settings are shown in **Bold**.

Entering Text

When you are setting certain menu selections, such as the Station ID, you may need to type text into the machine. Most of the number keys have three or four letters printed on them. The keys for **0**, **#** and ***** do not have printed letters because they are used for special characters.

By pressing the appropriate number key repeatedly, you can access the character you want.

Press Key	one time	two times	three times	four times
2	A	B	C	2
3	D	E	F	3
4	G	H	I	4
5	J	K	L	5
6	M	N	O	6
7	P	Q	R	S
8	T	U	V	8
9	W	X	Y	Z

Inserting spaces

To enter a space in the fax number, press ► once between numbers. To enter a space in the name, press ► twice between characters.

Making corrections

If you entered a letter incorrectly and want to change it, press ◀ to move the cursor under the incorrect character. Then press **Stop/Exit**. All letters above and to the right of the cursor will be deleted. Re-enter the correct character. You can also back up and type over incorrect letters.

Repeating letters

If you need to enter a character that is on the same key as the previous character, press ► to move the cursor to the right before you press the key again.

Special characters and symbols

Press *****, **#** or **0**, and then press ◀ or ► to move the cursor under the special character or symbol you want. Then press **Menu/Set** to select it.

Press ***** for (space) ! " # \$ % & ' ()
* + , - . / €

Press **#** for ; : < = > ? @ [] ^ _

Press **0** for É À È Ê Î Ç Ë Ö 0

G

Glossary

ADF (automatic document feeder)

The document can be placed in the ADF and scanned one page at a time automatically.

Auto Reduction

Reduces the size of incoming faxes.

Automatic fax transmission

Sending a fax without picking up the handset of the machine or an external phone.

Automatic Redial

A feature that enables your machine to redial the last fax number after five minutes if the fax did not go through because the line was busy.

Backup Print

Your machine prints a copy of every fax that is received and stored in memory. This is a safety feature so you will not lose messages during a power failure.

Batch Transmission

As a cost saving feature, all delayed faxes to the same fax number will be sent as one transmission.

Beeper Volume

Volume setting for the beep when you press a key or make an error.

Broadcasting

The ability to send the same fax message to more than one location.

Caller ID

A service purchased from the telephone company that lets you see the number (or name) of the party calling you.

Cancel Job

Cancels a programmed job, like Delayed Fax or Polling.

CNG tones

The special tones (beeps) sent by fax machines during automatic transmission to tell the receiving machine that a fax machine is calling.

Coding method

Method of coding the information contained in the document. All fax machines must use a minimum standard of Modified Huffman (MH). Your machine is capable of greater compression methods, Modified Read (MR), Modified Modified Read (MMR) and JBIG* (*FAX-2920 and MFC-7225N only), if the receiving machine has the same capability.

Communication error (or Comm. Error)

An error during fax sending or receiving, usually caused by line noise or static.

Compatibility group

The ability of one fax unit to communicate with another. Compatibility is assured between ITU-T Groups.

Contrast

Setting to compensate for dark or light documents, by making faxes or copies of dark documents lighter and light documents darker.

Delayed Fax

Sends your fax at a specified time later that day.

Distinctive Ring

A subscriber service purchased from the telephone company that gives you another phone number on an existing phone line. The Brother machine uses the new number to simulate a dedicated fax line.

Dual Access

Your machine can scan outgoing faxes or scheduled jobs into memory at the same time it is sending a fax from memory or receiving or printing an incoming fax.

Easy Receive

Enables your machine to respond to CNG tones if you interrupt a fax call by answering it.

ECM (Error Correction Mode)

Detects errors during fax transmission and resends the pages of the fax that had an error.

Extension phone

A telephone on the fax number that is plugged into a separate wall jack.

External phone

A telephone that is plugged into the EXT jack of your machine.

F/T Ring Time

The length of time that the Brother machine rings (when the Receive Mode setting is Fax/Tel) to notify you to pick up a voice call that it answered.

Fax Forwarding

Sends a fax received into the memory to another pre-programmed fax number.

Fax Journal

Lists information about the last 200 incoming and outgoing faxes. TX means Transmit. RX means Receive.

Fax Receive Code

Press this code (✕ 5 1) when you answer a fax call on an extension or external phone.

Fax Storage

You can store received faxes in memory.

Fax tones

The signals sent by sending and receiving fax machines while communicating information.

Fax/Tel

You can receive faxes and telephone calls. Do not use this mode if you are using a telephone answering device (TAD).

Fine resolution

Resolution is 203 x 196 dpi. It is used for small print and graphs.

Gray scale

The shades of gray available for copying and faxing photographs.

Group number

A combination of One-Touch and Speed-Dial numbers that are stored in a One-Touch key or Speed-Dial location for Broadcasting.

Handset Volume

Volume setting for the handset.

Help list

A printout of the complete Menu table that you can use to program your machine when you do not have the User's Guide with you.

Journal Period

The pre-programmed time period between automatically printed Fax Journal Reports. You can print the Fax Journal on demand without interrupting the cycle.

LCD (liquid crystal display)

The display screen on the machine that shows interactive messages during On-Screen Programming and shows the date and time when the machine is idle.

Manual fax

When you lift the handset or press **Hook/Hold** so you can hear the receiving fax machine answer before you press **Start** to begin sending.

Menu mode

Programming mode for changing your machine's settings.

OCR (optical character recognition)

MFC-7220 and MFC-7225N only:
The bundled ScanSoft® OmniPage® software application converts an image of text to text you can edit.

One-Touch

Keys on the machine's control panel where you can store numbers for easy dialing.

FAX-2820 and FAX-2920 only:

You can store a second number on each key if you press **Shift** and the One-Touch key together.

Out of Paper Reception

Receives faxes into the machine's memory when the machine is out of paper.

Overseas Mode

Makes temporary changes to the fax tones to accommodate noise and static on overseas phone lines.

Paging

This feature enables your machine to call your pager when a fax is received into its memory.

Pause

Allows you to place a 3.5 second delay in the dialing sequence stored on One-Touch keys and Speed-Dial numbers. Press **Redial/Pause** as many times as needed for longer pauses.

Photo resolution

A resolution setting that uses varying shades of gray for the best representation of photographs.

Polling

The process of a fax machine calling another fax machine to retrieve waiting fax messages.

Pulse

A form of rotary dialing on a telephone line.

Quick Dial List

A listing of names and numbers stored in One-Touch and Speed-Dial memory, in numerical order.

Real Time Transmission

When memory is full, you can send faxes in real time.

Remaining jobs

You can check which jobs are waiting in memory and cancel jobs individually.

Remote Access Code

Your own four-digit code (--- ✳) that allows you to call and access your machine from a remote location.

Remote Retrieval Access

The ability to access your machine remotely from a touch tone phone.

Resolution

The number of vertical and horizontal lines per inch. See: Standard, Fine, Super Fine and Photo.

Ring Delay

The number of rings before the machine answers in *Fax Only* and *Fax/Tel* mode.

Ring Volume

Volume setting for the machine's ring.

Scanning

The process of sending an electronic image of a paper document into your computer.

Search

An electronic, alphabetical listing of stored One-Touch, Speed-Dial and Group numbers.

Speed-Dial

A pre-programmed number for easy dialing. You must press the **Search/Speed Dial** key, #, and the three digit code, and **Start** to start the dialing process.

Standard resolution

203 x 97 dpi. It is used for regular size text and quickest transmission.

Station ID

The stored information that appears on the top of faxed pages. It includes the sender's name and fax number.

Super Fine resolution

203 x 392 dpi. Best for very small print and line art.

TAD (telephone answering device)

You can connect an external device or answering machine to the EXT. jack of your machine.

Telephone Answer Code (for Fax/Tel mode only)

When the machine answers a voice call, it pseudo/double-rings. You can pick up at an extension phone by pressing this code (# 5 1).

Temporary settings

You can select certain options for each fax transmission and copy without changing the default settings.

Tone

A form of dialing on the telephone line used for Touch Tone telephones.

Transmission

The process of sending faxes over the phone lines from your machine to the receiving fax machine.

Transmission Verification Report

A listing of each transmission, that shows its date, time and number.

User Settings

A printed report that shows the current settings of the machine.

Volume Amplify

Volume setting for the handset for a user who is hearing-impaired.

Product description

General

Memory Capacity	8 MB (FAX-2820) 16 MB (MFC-7220 and FAX-2920) 32 MB (MFC-7225N)
Automatic Document Feeder (ADF)	FAX-2820 and MFC-7220: Up to 20 pages (20 lb/Letter (80 g/m ²)) FAX-2920 and MFC-7225N: Up to 30 pages (staggered) Recommended Environment: Temperature: 68°F - 86°F (20° - 30°C) Humidity: 50% - 70% Paper: Xerox 4200 or Xerox 4024 (20 lb/Letter)
Paper Tray	250 Sheets (20 lb (80 g/m ²))
Printer Type	Laser
Print Method	Electrophotography by semiconductor laser beam scanning
LCD (Liquid Crystal Display)	16 characters × 1 line
Power Source	100 - 120V AC 50/60Hz
Power Consumption	FAX-2820 and FAX-2920: Copying: Average 475 W Sleep: Average 10 W Standby: Average 80 W MFC-7220 and MFC-7225N: Copying: Average 475 W Sleep: Average 10 W Standby: Average 80 W

Dimensions

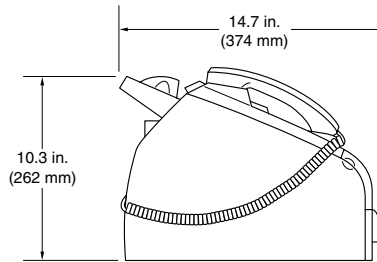
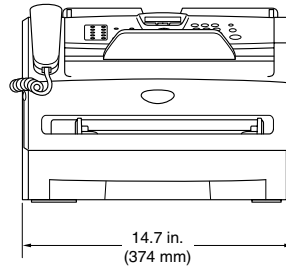

Weight

Without Drum/Toner Unit:
16.2 lb (7.35 kg)

Noise

Operating: 53 dB A or less
Standby: 30 dB A or less

Temperature

Operating: 50°F - 90.5°F (10 - 32.5°C)
Storage: 32°F - 104°F (0 - 40°C)

Humidity

Operating: 20 to 80% (without condensation)
Storage: 10 to 90% (without condensation)

Print media

Paper Input

Paper Tray

- Paper type:
Plain paper, Recycled paper or Transparencies²
- Paper size:
A4, Letter, Legal¹, Executive, A5, A6, B5 and B6
For more details, see *About paper* on page 1-8.
- Paper Weight:
16 - 28 lb (60 - 105 g/m²)
- Maximum paper tray capacity: Up to 250 sheets of 20 lb (80 g/m²) plain paper or up to 10 transparencies

Manual Feed Slot

- Paper type:
Plain paper, Recycled paper, Transparencies², Envelopes, Bond paper or Labels²
- Paper size:
Width: 2.75 - 8.5 in. (69.9 - 215.9 mm)
Length: 4.56 - 16 in. (116 - 406.4 mm)
For more details, see *About paper* on page 1-8.
- Paper Weight:
16 - 43 lb (60 - 161 g/m²)
- Maximum paper tray capacity: One sheet at a time

Paper Output

Up to 100 sheets of letter size plain paper (Face-down print delivery to the output paper tray)

¹ Legal paper cannot be stacked on the output paper tray.

² For transparency or label, we recommend removing printed pages from the output paper tray immediately after they exit the machine to avoid the possibility of smudging.

Copy

Color/Monochrome

Monochrome

Document Size

ADF Width: 5.8 to 8.5 in. (147.3 to 215.9 mm)

ADF Height: 3.9 to 14 in. (100 to 356 mm)

Multiple Copies

Stacks or Sorts up to 99 pages

Reduce/Enlarge

50% to 200% (in increments of 1%)

Resolution

Max. Print: 600 x 300 dpi

Max. Scan: 200 x 300 dpi

Fax

Compatibility	ITU-T Group 3
Coding System	MH/MR/MMR/JBIG* (*not available for FAX-2820 and MFC-7220)
Modem Speed	Automatic Fallback: 14400 bps (FAX-2820 and MFC-7220) 33600bps (FAX-2920 and MFC-7225N)
Document Size	ADF Width: 5.8 to 8.5 in. (147.3 to 215.9 mm) ADF Height: 3.9 to 14 in. (100 to 356 mm)
Scanning Width	Max. 8.2 in. (208 mm)
Printing Width	Max. 8.2 in. (208 mm)
Gray Scale	64 levels
Polling Types	Standard, Sequential
Contrast Control	Automatic/Light/Dark (manual setting)
Resolution	• Horizontal 203 dot/inch (8 dot/mm) • Vertical Standard - 98 line/inch (3.85 line/mm) Fine - 196 line/inch (7.7 line/mm) Photo - 196 line/inch (7.7 line/mm) Superfine - 392 line/inch (15.4 line/mm)
One-Touch Dial	10 (MFC-7220 and MFC-7225N) 20 (10 x 2) (FAX-2820 and FAX-2920)
Speed-Dial	200 stations
Broadcasting	270 stations (FAX-2820 and FAX-2920) 260 stations (MFC-7220 and MFC-7225N)
Automatic Redial	1 time after 5 minutes
Auto Answer	0, 1, 2, 3 or 4 rings
Communication Source	Public switched telephone network.
Memory Transmission	Up to 500 ¹ / 400 ² pages (FAX-2820 and MFC-7220) Up to 600 ¹ / 500 ² pages (FAX-2920 and MFC-7225N)
Out of Paper Reception	Up to 500 ¹ / 400 ² pages (FAX-2820 and MFC-7220) Up to 600 ¹ / 500 ² pages (FAX-2920 and MFC-7225N)

¹ "Pages" refers to the "Brother Standard Chart No. 1" (a typical business letter, Standard resolution, MMR code). Specifications and printed materials are subject to change without prior notice.

² "Pages" refers to the "ITU-T Test Chart #1" (a typical business letter, Standard resolution, MMR code). Specifications and printed materials are subject to change without prior notice.

Scanner (MFC-7220 and MFC-7225N only)

Color/Monochrome	Monochrome
TWAIN Compliant	Yes (Windows® 98/98SE/Me/2000 Professional/XP/Windows NT® Workstation Version 4.0) Mac OS® 9.1 - 9.2/Mac OS® X 10.2.4 or greater
WIA Compliant	Yes (Windows® XP)
Resolution	Up to 1200 × 1200 dpi (interpolated) Up to 200 × 400 dpi (optical)
Document Size	ADF Width: 5.8 to 8.5 in. (147.3 to 215.9 mm) ADF Height: 3.9 to 14 in. (100 to 356 mm)
Scanning Width	Max. 8.5 in. (215.9 mm)
Gray Scale	256 levels

Printer

Emulations	Brother Printing System for Windows® PCL6 and BR-Script (PostScript®) Level 3 (MFC-7225N only)
Printer Driver	Support for Windows® 98/98SE/Me/2000 Professional/XP/ Windows NT® Workstation Version 4.0 driver Support for Mac OS® 9.1 - 9.2/Mac OS® X 10.2.4 or greater
Resolution	Up to 1200 x 600 dots per inch (dpi) HQ1200 (up to 2400 x 600 dpi) (MFC-7225N only)
Print Quality	Normal printing mode Economy printing mode (save toner usage)
Print Speed	up to 14 pages/minute A4 size (For FAX-2820 and FAX-2920) up to 15 pages/minute letter size (For FAX-2820 and FAX-2920) up to 20 pages/minute (letter size) (For MFC-7220 and MFC-7225N) <small>* Based on Brother standard pattern. Does not include the time it takes to feed the paper.</small>
First Print	Less than 10 seconds

Interfaces

Interface

Parallel (MFC-7220 and MFC-7225N only)

USB

LAN cable (MFC-7225N only)

(Cables are not included.)

Recommended Cable

A bi-directional shielded parallel cable that is IEEE 1284 compliant and no longer than 6 feet (2.0 m).

A USB 2.0 interface cable that is not longer than 6 feet (2.0 m).

Ethernet UTP cable category 5 or greater.



Note

Your machine has a USB 2.0 Full-speed interface. This interface is compatible with USB 2.0 Hi-Speed; however, the maximum data transfer rate will be 12 Mbits/s. The machine can also be connected to a computer that has a USB 1.1 interface.

Please make sure you use a USB 2.0 interface cable that is no longer than 6 feet (2.0 m).

Download the optional software from the Brother Web Site (FAX-2820 and FAX-2920 users only)

You can download the Brother Printer Driver and PC-Fax software from the Brother Solutions Center so you can use your fax machine as a printer and send faxes from your PC.

Visit us at

<http://solutions.brother.com>

At the same time, you can download the manual for setting up and using the PC-Fax software.

Computer requirements

Minimum System Requirements						
Computer Platform & Operating System Version		Processor Minimum Speed	Minimum RAM	Recommended RAM	Available Hard Disk Space	
					for Drivers	for Applications (MFC-7220 and MFC-7225N only)
Windows® Operating System	98, 98SE	Pentium® II or equivalent	32 MB	64 MB	90 MB	130 MB
	Me		64 MB	128 MB		
	NT® Workstation 4.0		128 MB	256 MB	150 MB	220 MB
	2000 Professional XP					
Apple® Macintosh® Operating System	Mac OS® 9.1 - 9.2 (Printing, Scanning ¹ and PC Fax Send Only)	All base models meet minimum Requirements		64 MB	80 MB	200 MB
	Mac OS® X 10.2.4 or greater		128 MB	160 MB		
NOTE: All registered trademarks referenced herein are the property of their respective companies.						
For the latest drivers, go to the Brother Solutions Center at http://solutions.brother.com/						

¹ Dedicated "Scan" key and direct Network Scanning (MFC-7225N) supported in Mac OS® X 10.2.4 or greater.

Consumable items

Toner Cartridge Life (TN-350) Starter Toner Cartridge: Approx 1,500 pages*
Standard Toner Cartridge: Approx 2,500 pages**
* When printing letter or A4 size paper at 5% print coverage
+ Require additional purchase



Note

Toner life expectancy will vary depending upon the type of average print job.

Drum Unit Life Expectancy (DR-350) Approx 12,000 pages



Note

There are many factors that determine the actual drum life, such as temperature, humidity, type of paper, toner you use and number of pages per print job.

Network (LAN) (MFC-7225N only)

LAN	You can connect your MFC to a network for Network Printing, Network Scanning and PC Fax Send. Also included is the Brother BRAdmin Professional Network Management software.
Support for	Windows® 98/98SE/Me/2000/XP/Windows NT® Workstation Version 4.0 Mac OS® 9.1 - 9.2/Mac OS® X 10.2.4 or greater*
Protocols	Ethernet 10/100 BASE-TX Auto Negotiation TCP/IP ARP, RARP, BOOTP, DHCP, APIPA (Auto IP), NetBIOS Name Resolution, WINS, DNS Resolver, LPR/LPD, Custom Raw Port/Port9100, SMTP Client, IPP, FTP Server, mDNS, TELNET, SNMP, HTTP *Mac OS® 9.1 - 9.2 (Brother Laser Driver over TCP/IP) *Mac OS® X 10.2.4 or greater (mDNS) *Network Scanning is available for Mac OS® 10.2.4 or greater. Included Utilities: BRAdmin Professional (Windows®)



Note

BRAdmin Professional is not supported in Mac OS®.

Optional External Wireless Print/Scan Server (NC-2200w) (MFC-7220 and MFC-7225N only)

NC-2200w External Wireless Print/Scan Server (Optional)

Connecting the optional External Wireless Print/Scan Server (NC-2200w) to the USB port of your machine will allow you to print and scan over a wireless network.

Network types

IEEE 802.11b wireless LAN

Support for

Windows® 98/98SE/Me/2000/XP/Windows NT® Workstation Version 4.0
Mac OS® X 10.2.4 or greater

Protocols

TCP/IP
ARP, RARP, BOOTP, DHCP, APIPA (Auto IP), WINS/NetBIOS, DNS, LPR/LPD, Port9100, SMB Print, IPP, RawPort, mDNS, TELNET, SNMP, HTTP



Note

You can assign the **Scan** key to only one networked computer.

Optional External Print Server (NC-2100p) (MFC-7220 and MFC-7225N only)

NC-2100p External Print/Server (Optional)	Connecting the optional External Print Server (NC-2100p) to the Parallel port of your MFC will allow you to print over a wired Ethernet network.
Support for Protocols	Windows® 98/98SE/Me/2000/XP/Windows NT® Workstation Version 4.0 TCP/IP (LPR/LPD), IPP, FTP, HTTP, TELNET, Port 9100, SMTP, POP3, TFTP, SNMP, DHCP, BOOTP, RARP, NetBEUI

**Note**

The software items referring to the User's Guide on the CD-ROM are for the MFC-7220 and MFC-7225N only.

- A**
- Access codes, storing and dialing 5-4
 - Accessories and suppliesii
 - ADF (automatic document feeder) 1-7
 - ADF cover 11-7
 - Answering machine (TAD)A-5
 - connectingA-6
 - Apple® Macintosh®
 - See Software User's Guide on the CD-ROM.
 - Automatic
 - fax receive 4-1
 - Easy Receive 4-3
 - fax redial 3-3
 - transmission 3-3
- B**
- Broadcasting 3-7
 - setting up Groups for 5-3
 - Brother
 - accessories and suppliesii
 - Brother numbers i
 - Customer Service i
 - fax back systemii
 - Frequently asked questions (FAQs) i
 - product support i
 - Warrantiesiii, iv, vi
- C**
- Caller IDA-3
 - print listA-3
 - view listA-3
 - Canceling
 - Fax Forwarding 6-1
 - fax jobs in memory 3-8
 - jobs awaiting redial 3-8
 - Paging 6-6
 - Cleaning
 - corona wire 11-24
 - drum unit 11-17
 - laser scanner window 11-22
 - scanner glass 11-22
 - CNG tones1-13
 - Connecting
 - external TAD A-5
 - external telephone A-5
 - two-line external TAD or telephone A-8
 - Consumable items S-8
 - Control panel overview 1-5, 1-6
 - ControlCenter2.0
 - See Software User's Guide on the CD-ROM.
 - Copy
 - contrast8-7
 - default settings8-7
 - Enlarge/Reduce8-3
 - enter Copy mode8-1
 - multiple copies8-2
 - Out of Memory8-7
 - Page Layout8-6
 - printable area8-1
 - Quality key8-5
 - quality setting8-7
 - single copy8-1
 - Cordless phone A-5
 - Cover page
 - custom comments3-9
 - for all faxes3-10
 - for next fax only3-9
 - printed form3-10
 - Credit card numbers5-4
 - Custom telephone features on a single line A-9
- D**
- Date and Time2-1
 - Delayed Batch Transmission3-11

- Dialing
 - a pause 5-4
 - access codes and credit card numbers 5-4
 - automatic fax redial 3-3
 - automatic transmission 3-3
 - Groups 3-7
 - manual 3-1
 - One-Touch 3-1
 - Speed-Dial 3-2
 - Distinctive Ring A-1
 - setting ring pattern A-2
 - turning off A-2
 - Drum Unit
 - cleaning 11-17, 11-24
 - replacing 11-27
 - Dual Access 3-6
- E**
- ECM (Error Correction Mode) 1-13
 - Equalization 11-20
 - Error messages on LCD 11-1
 - Comm. Error 11-1
 - No Paper Fed 11-3
 - Not Registered 3-2
 - Out of Memory 11-4
 - while scanning a document 8-7
 - Unable to Init. 11-5
 - Unable to Print 11-5
 - Unable to Scan 11-5
 - Extension telephone, using A-4
 - External telephone, connecting A-5
- F**
- Fax codes
 - changing 6-5, A-5
 - Fax Receive Code 4-3, A-4
 - Remote Access Code 6-5
 - Telephone Answer Code A-4
 - Fax Forwarding
 - changing remotely 6-6, 6-7
 - programming a number 6-1
 - Fax Storage 6-2
 - printing from memory 4-5
 - turning on 6-2
 - Fax, stand-alone
 - receiving 4-1
 - at the end of a conversation 4-4
 - compatibility 11-20
 - Easy Receive 4-3
 - Fax Forwarding 6-1
 - from extension phone A-4
 - Paging 6-2
 - Polling Receive 4-5
 - reducing to fit on paper 4-4
 - retrieving from a remote site 6-7
 - Ring Delay, setting 4-2
 - Sequential Polling 4-6
 - sending 3-1
 - at the end of a conversation 3-4
 - automatic 3-3
 - Broadcasting 3-7
 - canceling from memory 3-8
 - compatibility 11-20
 - contrast 3-5
 - enter Fax mode 3-1
 - from ADF 3-3
 - from memory (Dual Access) 3-3, 3-6
 - from PC
 - See Software User's Guide on the CD-ROM.
 - overseas 3-10
 - Real Time Transmission 3-6
 - resolution 3-5
 - Fax/Tel mode
 - answering at extension phones A-4
 - double-ringing (voice calls) 4-3
 - F/T Ring Time 4-3
 - Fax Receive Code A-4
 - receiving faxes A-4
 - Ring Delay 4-2
 - Telephone Answer Code A-4
 - FCC notices 10-1
- G**
- Gray scale S-4, S-5
 - Groups for Broadcasting 5-3
- H**
- Handset Volume 2-6
 - HELP
 - LCD messages B-1
 - using navigation keys B-2
 - Menu Table B-1, B-3

J

Jacks

- convert to RJ11 jack
triplex adapterA-7

EXT

- external telephoneA-5
- TAD (answering machine)A-5

Jams

- document 11-7
- paper 11-7

L

- LCD (liquid crystal display) B-1, B-2
- Help List 7-2

M

Macintosh®

- See Software User's Guide on the CD-ROM.

- Maintenance, routine 11-21

Manual

- dialing 3-1
- receive 4-1

- Memory Security 2-10

- Memory Storage B-1

- Menu Selection Table B-1

Mode, entering

- Copy 8-1
- Fax 3-1
- Scan 1-6

- Multi-line connections (PBX)A-9

N

Networking

printing

- See Software and Network User's Guide on the CD-ROM.

scanning

- See Software and Network User's Guide on the CD-ROM.

O

One-Touch

- changing 5-2
- setting up 5-1
- using 3-1

- Out of Area (Caller ID) A-3

- Out of Memory message3-4

P

- Paging6-2

- programming your pager number6-1

- Paper 1-8, S-3

- Size2-4

- size of document 1-7

- Type2-4

PaperPort®

- See Software User's Guide on the CD-ROM.

PC Faxing

- See Software User's Guide on the CD-ROM.

Phone line

- connections A-6

- difficulties 11-11

- multi-line (PBX) A-9

- roll over lines A-7

- two-line phone system A-7

- Polling4-5

- Power failure B-1

Print

- difficulties 11-11

- drivers S-5

- fax from memory4-5

from PC

- See Software User's Guide on the CD-ROM.

- paper jams 11-7

- quality 1-8, 2-4, 11-16

- report7-2

- resolution S-5

- specifications S-5

- Programming your machineB-1, B-2

Q

Quick-Dial

Access codes and credit card numbers

- setting up5-4

- Broadcasting3-7

- using Groups3-7

Group dial

- changing5-2

setting up Groups for

- Broadcasting5-3

One-Touch dial	
changing	5-2
setting up	5-1
using	3-1
Search	3-2
Speed-Dial	
changing	5-2
setting up	5-2
using	3-2

R

Receive Mode	4-1
External TAD	4-1
Fax Only	4-1
Fax/Tel	4-1
Manual	4-1
Redial/Pause	3-3
Reducing	
copies	8-4
incoming faxes	4-4
Remote Retrieval	6-5
access code	6-5
commands	6-6
getting your faxes	6-7
Remote Setup	
See Software User's Guide on the CD-ROM.	
Reports	7-1
Caller ID List	A-3
Fax Journal	7-2
Journal Period	7-2
Help List	7-2
how to print	7-2
Network Configuration	7-2
Quick-Dial List	7-2
Transmission Verification	7-1
User Settings	7-2
Resolution	
copy	S-3
fax (Standard, Fine, SuperFine, Photo)	S-4
print	S-5
scan	S-5
setting for next fax	3-5
Ring Delay, setting	4-2

S

Safety Instructions	vii, 10-4
Setting Lock	2-12
Setup	
Date and Time	2-1
Station ID (fax header)	
entering text	2-2
Shipping the machine	11-20
Sleep Time	2-8
Speed-Dial	
changing	5-2
setting up	5-2
using	3-2

T

TAD (telephone answering device),	
external	4-1, A-5, A-8
connecting	A-5, A-6
receive mode	4-1
recording OGM	A-7
with two-line jack	A-8
Text, entering	B-11
special characters	B-11
Toner cartridge	
replacing	11-24
Troubleshooting	11-1
document jam	11-7
error messages on LCD	11-1
if you are having difficulty	
incoming calls	11-12
paper handling	11-14
paper jam	11-7
phone line	11-20
printer difficulties	11-13
printing	11-11, 11-13
paper jam	11-7
Two-line phone system	A-7

V

Volume, setting	2-5
beeper	2-5
handset	2-6
Volume Amplify for	
the hearing-impaired	2-6, 2-7
ring	2-5
speaker	2-5

W

Warranties	iii
Canada	vi
Notice-Disclaimer	iii
USA	iv
Windows®	
See Software User's Guide on the CD-ROM.	
World Wide Web	i

R

Remote Retrieval Access card

If you plan to receive fax messages while away from your machine, carrying the Remote Retrieval Access Card printed below will serve as a convenient reminder of the retrieval procedures. Simply cut out the card and fold it to fit your wallet or organizer. Keeping it handy will help you derive the full benefit of your machine's Paging, Fax Forwarding and Remote Retrieval features.

REMOTE RETRIEVAL ACCESS CARD	
CHECK RECEIVING STATUS Press 9 7 1 1 long beep — Fax messages 3 short beeps — No messages	Using Remote Access Code 1 Dial your fax number from a telephone or fax machine using touch tone. 2 When your machine answers, immediately enter your Remote Access Code (3 digits followed by *). 3 Your machine signals the kinds of messages it received: 1 long beep — Fax messages No beeps — No messages. 4 After 2 short beeps, enter a command. 5 Press 9 0 to reset your machine when you finish. 6 Hang up.
CHANGE RECEIVE MODE Press 9 8 then for External TAD, press 1 . Fax/Tel, press 2 . Fax Only, press 3 .	
EXIT REMOTE OPERATION Press 9 0 .	

Changing Remote Access Code

- 1 Press **Menu/Set**, **2**, **5**, **2**.
- 2 Enter a three-digit code using numbers **0-9**, ***** or **#**.
The ***** cannot be changed.
- 3 Press **Menu/Set**.
- 4 Press **Stop/Exit**.

Remote Commands

CHANGE PAGING/FAX FORWARDING SETTING

Press **9**, **5**.
then to Turn feature **Off**, press **1**.
Select **Fax Forwarding**, press **2**.
Select **Paging**, press **3**.

Fold →

Program Fax Forwarding Number, press **4**. Enter the new fax number where you want your fax messages forwarded followed by **#**, **#**.

Turn Fax Storage On, press **6**.

RETRIEVE A FAX

Press **9**, **6**.
then to **Retrieve all faxes**, press **2**.
then enter the number of remote fax machine followed by **#**, **#**.
After the beep, hang up and wait.
Erase all fax messages, press **3**.

← Fold

EQUIPMENT ATTACHMENT LIMITATIONS (Canada only)

NOTICE

This product meets the applicable Industry Canada technical specifications.

NOTICE

The Ringer Equivalence Number is an indication of the maximum number of devices allowed to be connected to a telephone interface. The termination on an interface may consist of any combination of devices subject only to the requirement that the sum of the RENs of all the devices does not exceed five.

Brother International Corporation
100 Somerset Corporate Boulevard
P.O. Box 6911
Bridgewater, NJ 08807-0911 USA

Brother International Corporation (Canada) Ltd.
1 rue Hôtel de Ville,
Dollard-des-Ormeaux, QC, Canada H9B 3H6



Visit us on the World Wide Web
<http://www.brother.com>

These machines are made for use in the USA and Canada only. We cannot recommend using them overseas because it may violate the Telecommunications Regulations of that country and the power requirements of your multi-function center may not be compatible with the power available in foreign countries. **Using USA or Canada models overseas is at your own risk and may void your warranty.**

USA/CAN